

PAPER CRAFT

<http://www.canon.com/c-park/en/>

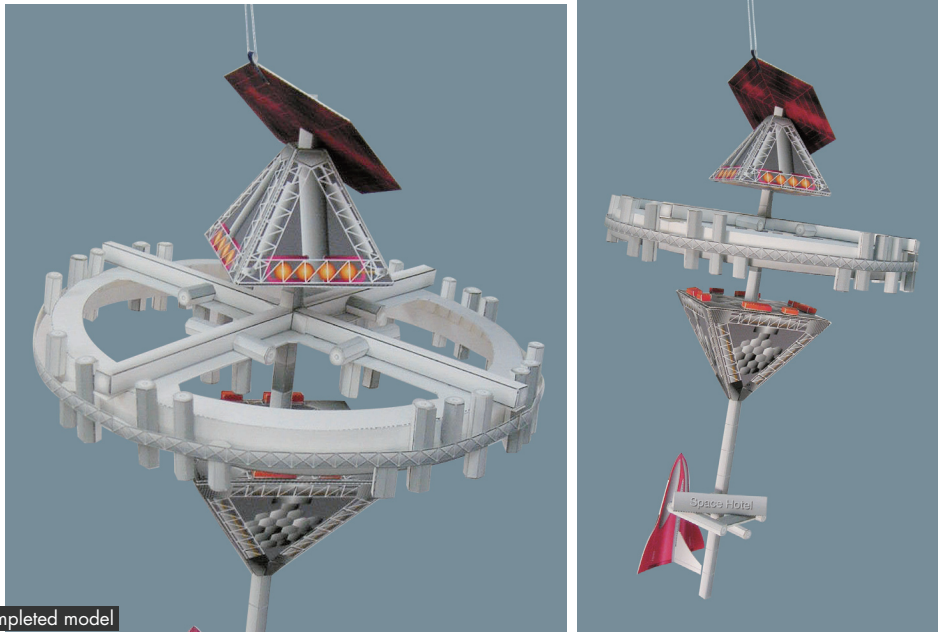

View of completed model

Space Hotel

Editor: SHMZ CORPORATION

A hotel intended to allow ordinary people to stay in outer space, consisting of 64 rooms with a total length of 240 m. Accommodation facilities include guest room modules and public areas. Guest rooms are arranged in a ring to give guests a constant view of Earth and to give guest rooms an artificial gravity of 0.75 G through centrifugal force, creating a low-stress, familiar environment. The public area offers zero gravity and is designed to allow various recreations activities, including various sports.

*This model was designed for Papercraft and may differ from the original in some respects.

■ **Parts list (pattern):** Four A4 sheets (No.5 to No.8)

■ **No. of Parts:** 189 (Including spare parts.)

*Build the model by carefully reading the Assembly Instructions, in the parts sheet page order.

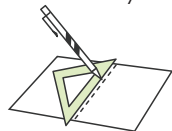

*Hint: Trace along the folds with a ruler and an exhausted pen (no ink) to get a sharper, easier fold.

Before starting assembly: Writing the number of each section on its back side before cutting out the sections is highly recommended. (* This way, you can be sure which section is which even after cutting out the sections.)

- Indicates where sections should be glued together.
- The grey diagonal lines indicate the portion to be cut out.

Introduction: The configuration involves many prismatic rods. Given below are the basic craftwork techniques for preparing prismatic rods.

● **Making prismatic rods.** ⇒ [square rod] parts 9, 10, 11, and 12.

Make a crease in the part and apply a small amount of glue (e.g., woodwork adhesive) with a toothpick, starting from the end of the part. Move the gluing point gradually while pressing with a scale. Arrange into a square after the glue dries.

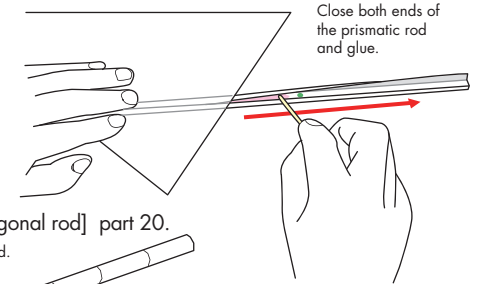

● **Making a prismatic rod.** ⇒ [hexagonal rod] part 20.

The process is the same as that for a square rod. Make an even crease, allow the margins to overlap to which glue is to be applied, and begin applying glue to gradually from the front end.

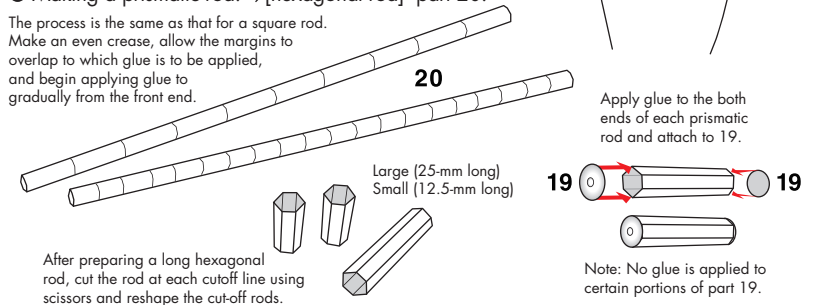

After preparing a long hexagonal rod, cut the rod at each cutoff line using scissors and reshape the cut-off rods.

Note: No glue is applied to certain portions of part 19.

Assembly Instructions



Mountain fold(dotted line)
Make a mountain fold.



Valley fold(dashed and dotted line)
Make a valley fold.



Scissors line(solid line)
Cut along the line.



Cut in line(solid line)
Cut along the line.

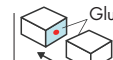

Glue
The glue spot(colored dot) shows where to apply the glue.

● **Glue spot(Red dot)**

Glue parts with the same number together.

● **Glue spot(Green dot)**

Glue within the same part.

● **Glue spot(Blue dot)**

Glue to the rear of the other part.

Tools and materials



Scissors, set square, glue(We recommend stick glue), pencil, used ballpoint pen, toothpicks, tweezers, (useful for handling small parts).
Prepare a piece of cotton thread.

Assembly tip



Before gluing, crease the paper along mountain fold and valley fold lines and make sure rounded sections are nice and stiff.

Caution



Glue, scissors and other tools may be dangerous to young children so be sure to keep them out of the reach of young children.

Space Hotel: Assembly Instructions

Assemble parts 9, 10, and 12 into square rods (see the previous page). Place the three parts so that they complete the plus sign and glue them on top of part 1.

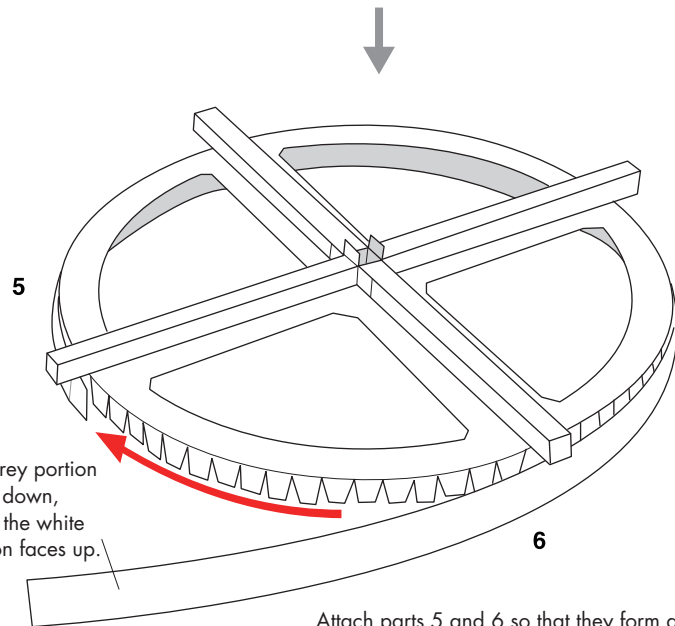
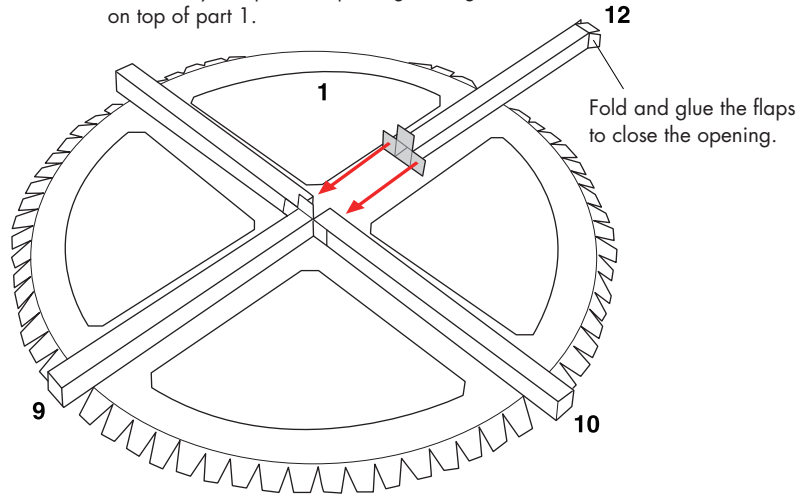

Attach parts 5 and 6 so that they form a circle. Glue them to the circumference of part 1.

Prepare large and small hexagonal rods for part 20 (see the previous page).

Place the part 20 rods along the circumference of parts 5 and 6 by aligning the center of each rod on the vertical lines of parts 5 and 6, and glue them in place. Place the smaller hexagonal rods of part 20 by aligning the upper or bottom ends on the center line of the circumference. Attach them in proportionally appropriate positions according to your preference. Apply glue to both ends of the rods and attach the part 19 disks to them.

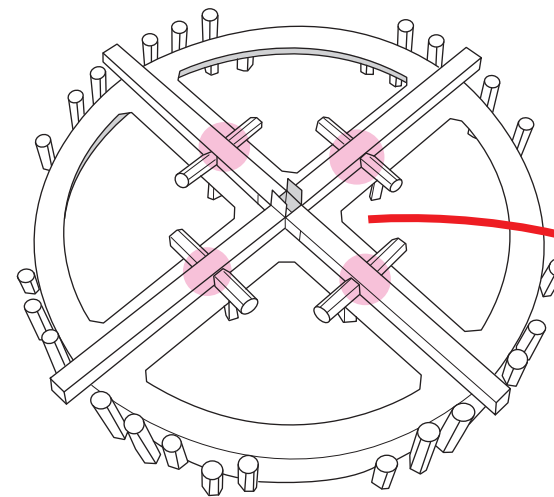
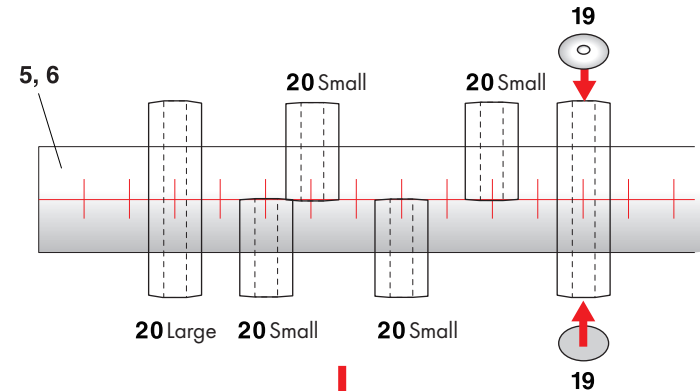

Place a small hexagonal rod of part 20 horizontally across each path of part 1. (Do not attach part 19 disks at the ends of hexagonal rods that connect to the plus-sign formed square rods.)

Glue eight small part 20 hexagonal rods vertically to the bottom of the paths.

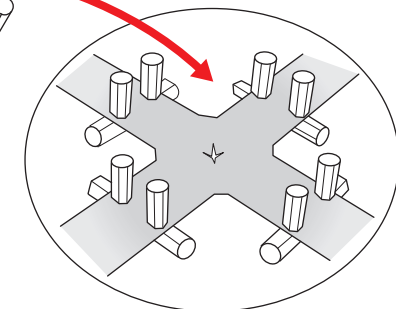

Place these rods under the small hexagonal rods on the surface. (Do not attach part 19 disks at the connecting ends.)

Space Hotel: Assembly Instructions

Make a strip by joining four pieces of part 16.
Roll the strip around part 1, to which part 20 has been glued,
at the center of the outer circumference.



16 The grey portion faces down,
while the white portion faces up.

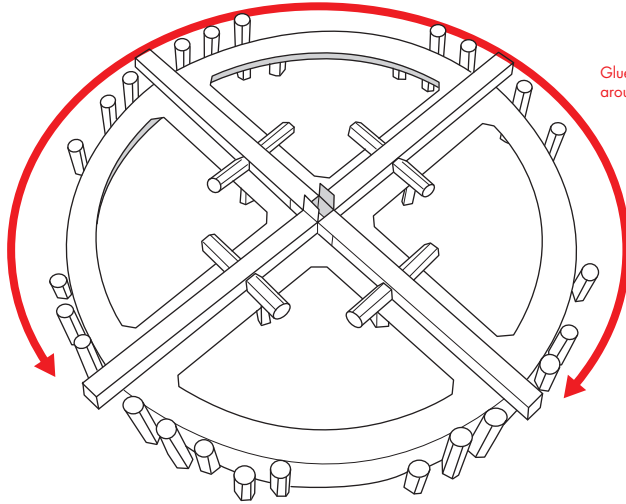

Glue to the center of each part 20
around the circumference.

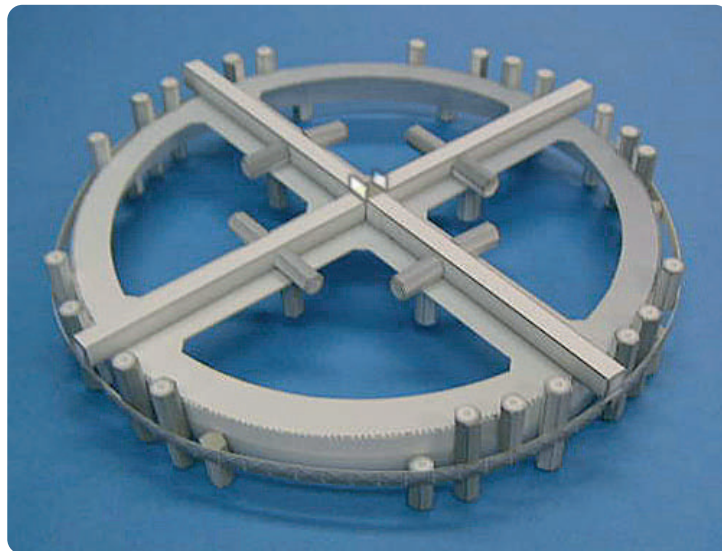

Completed residential quarter of the hotel.

● Assembling the shuttle

Glue together the upper fuselage, part 2, and lower fuselage, part 3.
Insert the tail unit, part 4, into the slit of part 2 from the backside,
and glue the lower part to the inside of part 3.

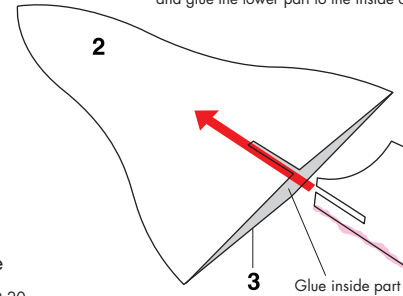

4 Fold the tail unit in the middle.
Glue the backsides together.

3 Glue inside part 3.

● Shuttle landing passage

Assemble A, B, C, and D of part 20.
Prepare the above-mentioned hexagonal rods,
then assemble and glue, as shown in the diagram.
Attach part 19 to both ends of A and to one end of C.

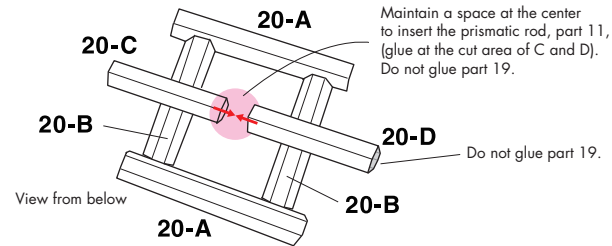

Maintain a space at the center
to insert the prismatic rod, part 11,
(glue at the cut area of C and D).
Do not glue part 19.

Do not glue part 19.

View from below

● Recreation center and electrical power district

Prepare a square pyramid
by gluing parts 7 and 8.

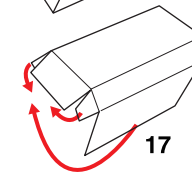
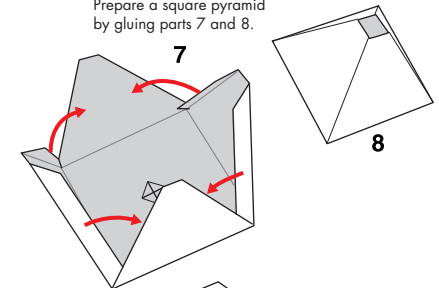

Configure parts 17 and 18 into box shapes.
Glue the bottoms of the boxes to the specified
position on part 7. (Square bottoms of the pyramids)

● Solar panel

Fold in the middle and glue together.

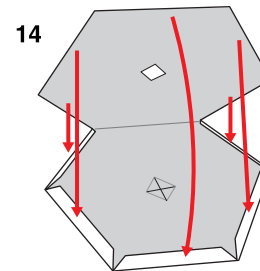

Roll part 13 around
an appropriate rod-shaped object.

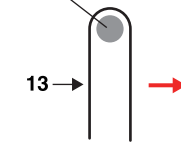

Diameter: About 3 mm

Align the bottom
and glue.

Glue to the corner
of the red surface.

● Plate

Fold into a triangular rod
and glue at the bottom.



● Attaching to part 11, center pole

- (1) Assemble part 11 into a square rod.
- (2) Apply glue to the center hole of part 1 and insert part 11. Fix part 11 68 mm from the top. Glue the margins to which glue is to be applied of the cross-shaped parts 9 and 12 to the specified positions of part 11.
- (3) Apply glue to the center of the lower hole of part 8, insert part 11, and glue 20 mm from the top of part 11.
- (4) Apply glue to the center of the upper hole of part 7, insert part 11, and glue 130 mm from the bottom of part 11.

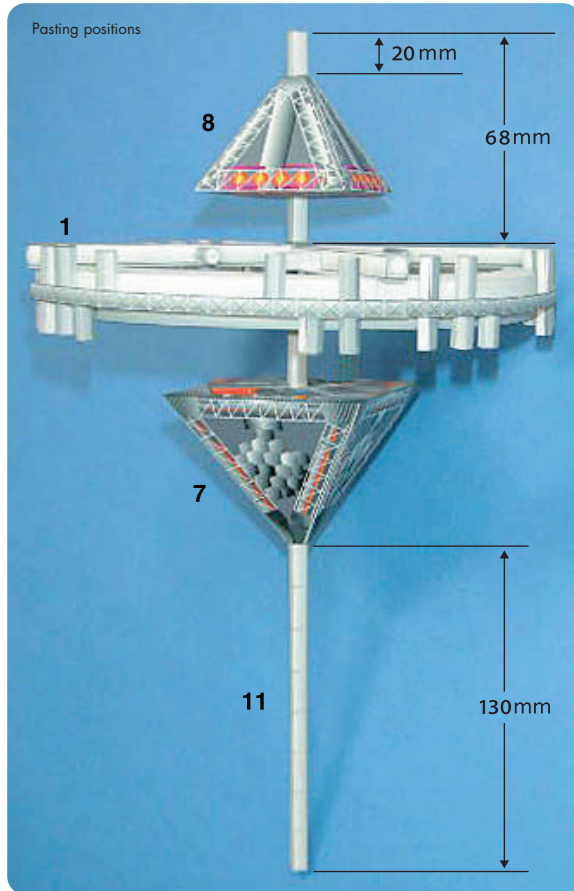

● Attaching part 14

Apply glue to the center hole of part 14, and attach to the top of parts 11 at an angle, as shown in the diagram. Select the desired tilt for part 14. (Upper part: blue; lower part: red.)

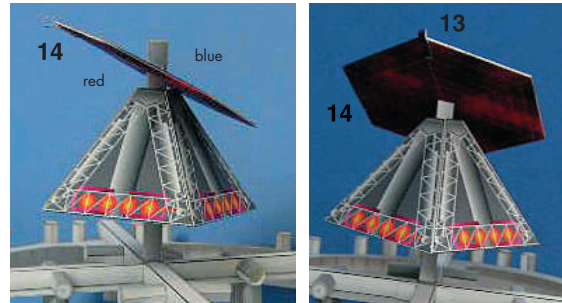

● Attaching A, B, C, and D of part 20 (landing passage for the shuttle) and attaching the shuttle

Pinch the lower part of part 11 between the cut ends of part 20-C and part 20-D, and glue to fix as shown in the diagram. Glue the outside cut end of part 20-D to part 2 of the shuttle.

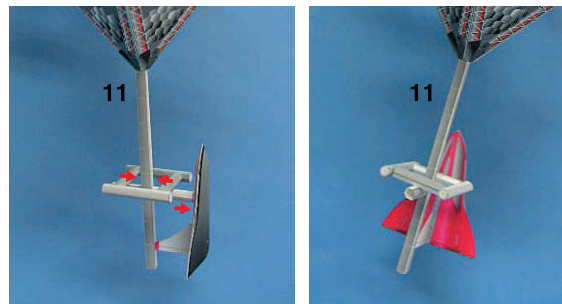

● Hanging the paper craft

Pass a cotton thread through part 13 and hang the paper craft from the ceiling. It should appear to float in space, rotating at the slightest breeze.



Glue part 15, Plate, to the landing passage for the shuttle.

Space Hotel: Pattern

Canon ® is a registered trademark of Canon Inc. © Canon Inc. © T.K.N+

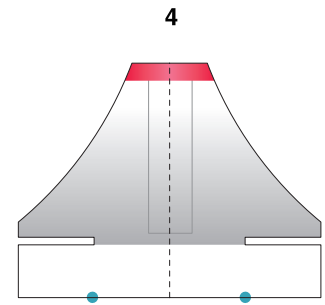
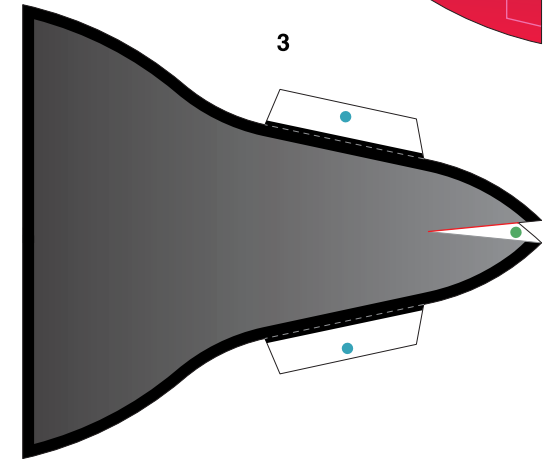
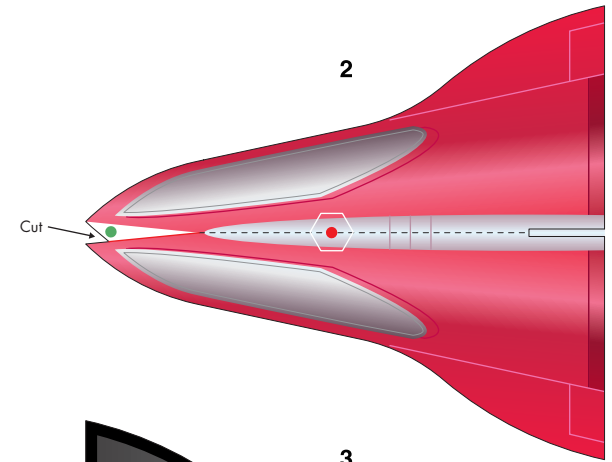
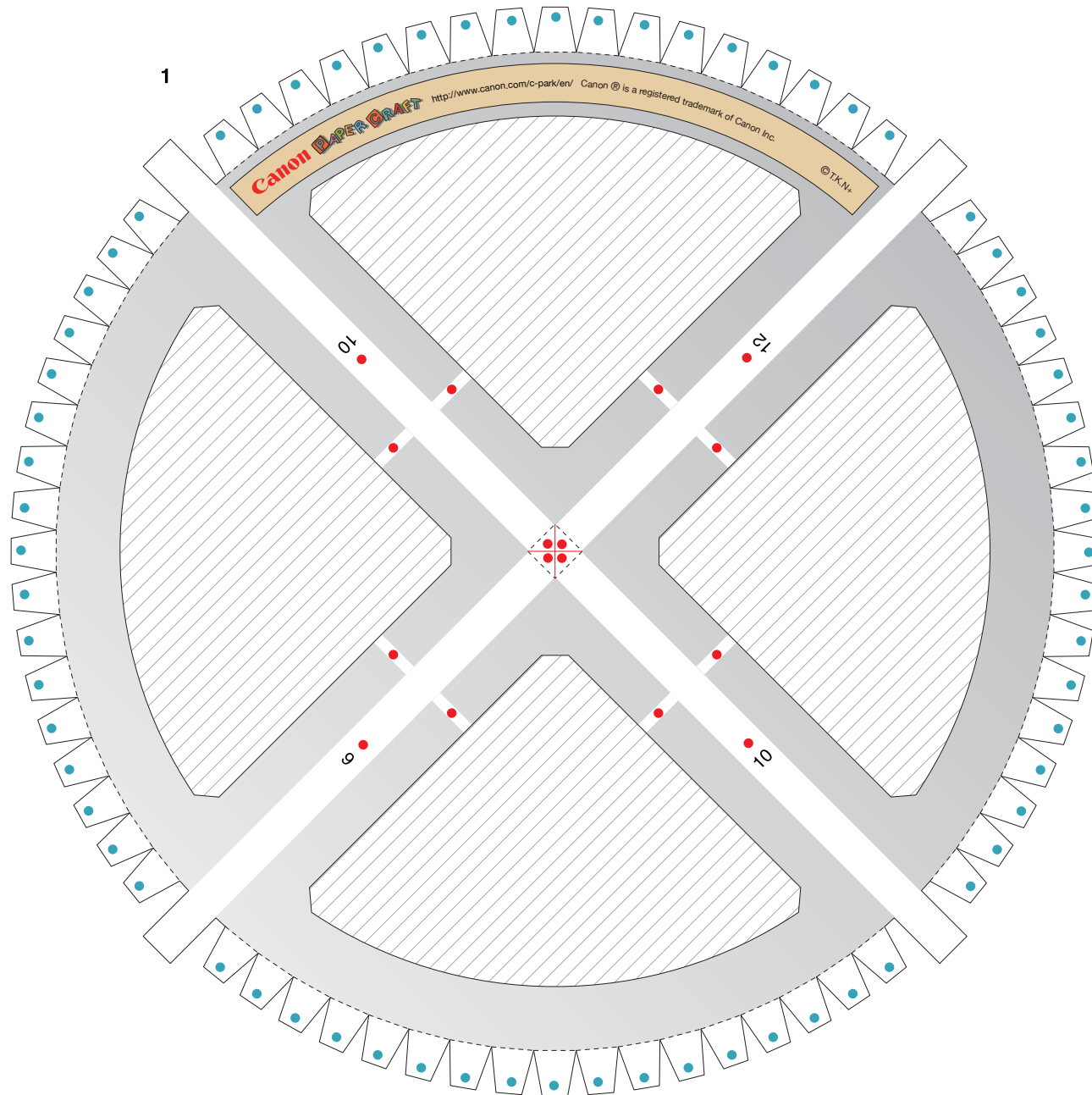

Space Hotel: Pattern

Canon ® is a registered trademark of Canon Inc. © Canon Inc. © T.K.N+



5



6



7

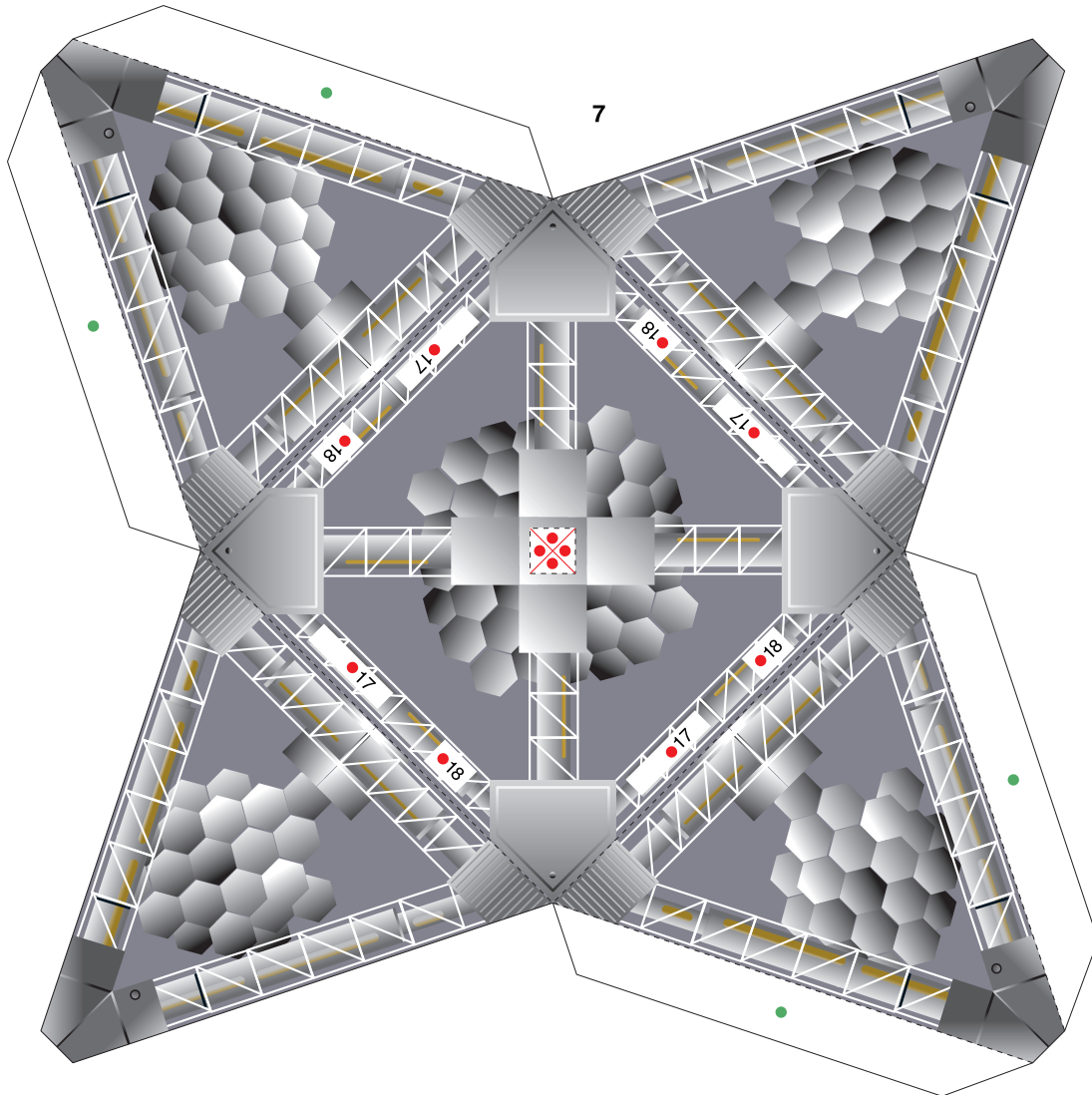

8

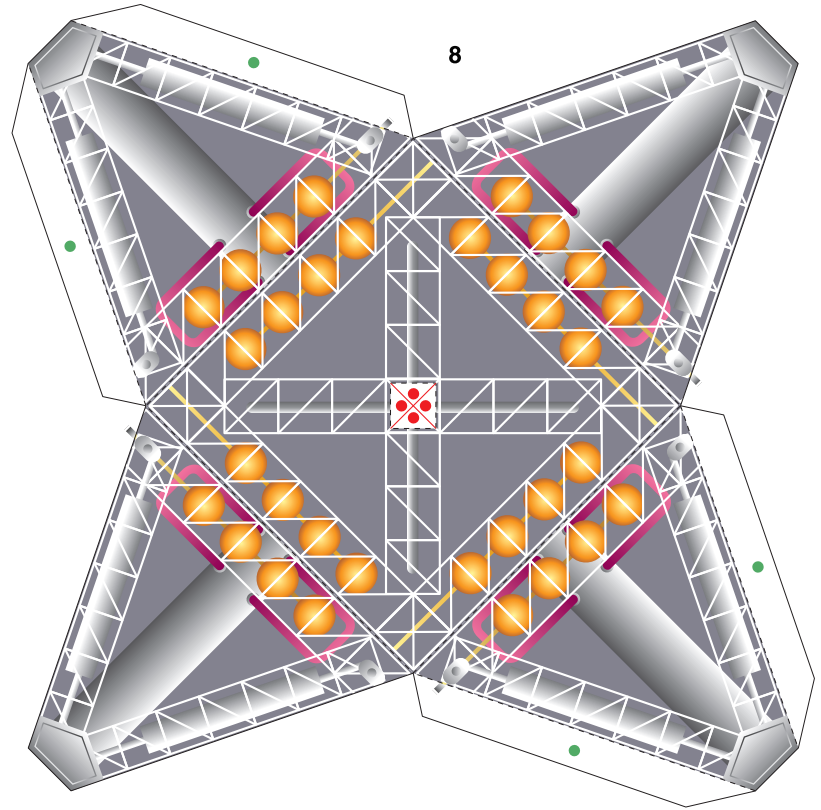

6

Space Hotel: Pattern

Canon ® is a registered trademark of Canon Inc. © Canon Inc. © T.K.N+

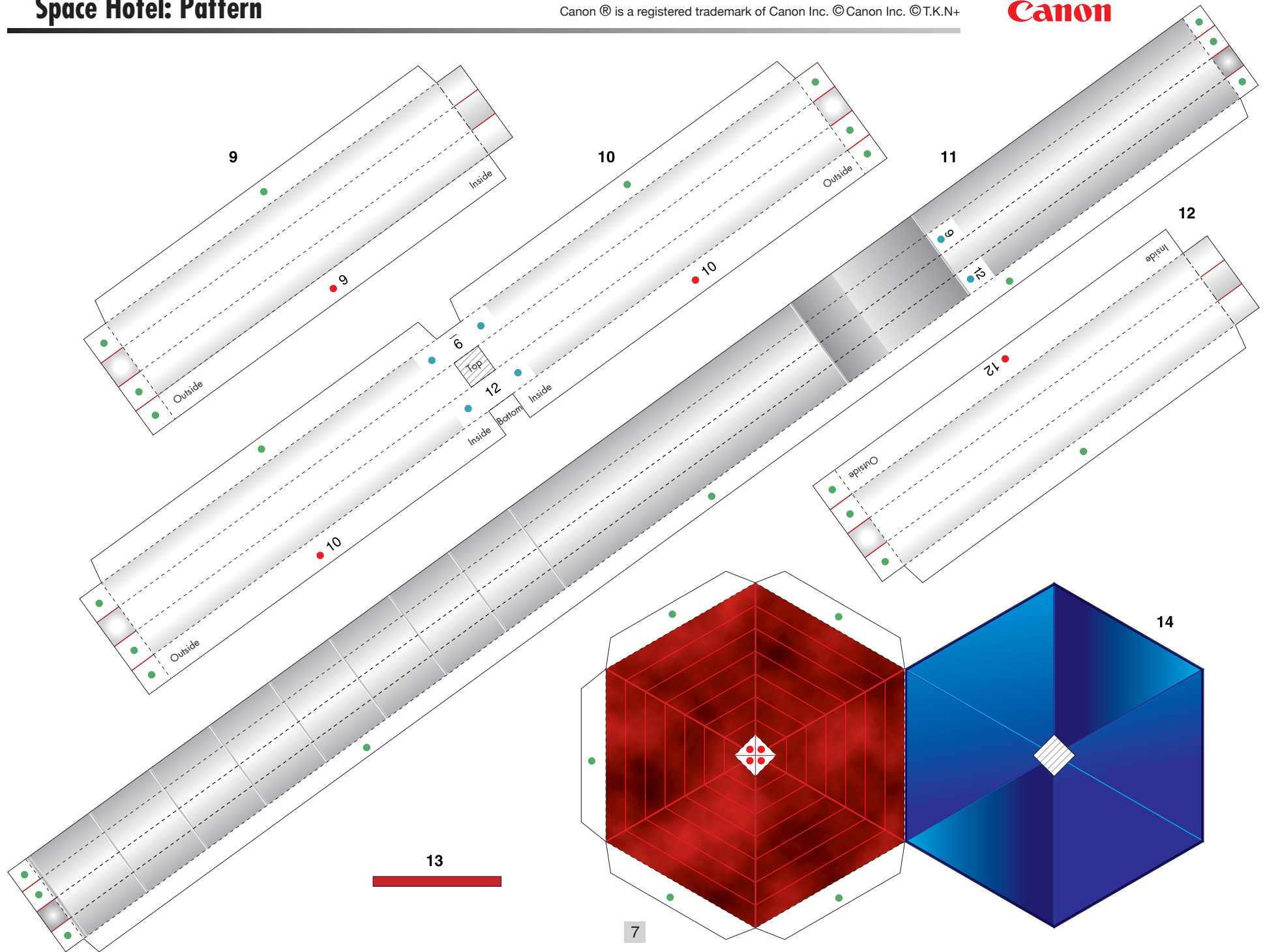

Space Hotel: Pattern

Canon ® is a registered trademark of Canon Inc. © Canon Inc. © T.K.N+

