

# DATA SHEET



## **TEA6823T; TEA6825T** In Car Entertainment (ICE) car radio

Preliminary specification  
File under Integrated Circuits, IC01

1998 Mar 24

**In Car Entertainment (ICE) car radio****TEA6823T; TEA6825T****FEATURES****General**

- FM mixer for conversion from FM-IF<sub>1</sub> = 72.2 MHz to FM-IF<sub>2</sub> = 10.7 MHz
- AM mixer for conversion from AM-IF<sub>1</sub> = 10.7 MHz to AM-IF<sub>2</sub> = 450 kHz
- FM-IF gain stage
- Crystal oscillator providing mixer frequencies and references for IF-count and stereo decoder
- FM quadrature demodulator with automatic centre frequency adjustment and THD compensation
- Level, multi-path and noise detectors
- Soft mute
- Stereo noise cancelling and variable de-emphasis
- PLL stereo decoder
- Noise blanker
- AM IF-amplifier and demodulator
- I<sup>2</sup>C-bus transceiver with interface to enable direct data transfer to radio front-end
- IF-count for AM and FM
- Reference frequency generation for PLL synthesizer.

**Stereo decoder**

- Adjustment-free PLL VCO
- Pilot depending mono/stereo switching
- Analog control of mono/stereo blend
- Adjacent channel noise suppression (114 kHz)
- Pilot cancelled
- Analog control of de-emphasis
- Integrated low-pass filters for 190 kHz adjacent channel interferences and signal delay for interference absorption circuit.

**GENERAL DESCRIPTION**

The TEA6823T together with the TEA6811T and the TEA6825T together with the TEA6810T form an AM/FM electronic tuned car radio in a double conversion receiver concept.

**ORDERING INFORMATION**

| TYPE NUMBER | PACKAGE |   |          |
|-------------|---------|---|----------|
|             | NAME    | DESCRIPTION   | VERSION  |
| TEA6823T    | VSO56   | plastic very small outline package; 56 leads            | SOT190-1 |
| TEA6825T    | VSO56   | plastic very small outline package; 56 leads; face down | SOT190-2 |

## In Car Entertainment (ICE) car radio

## TEA6823T; TEA6825T

## QUICK REFERENCE DATA

| SYMBOL                            | PARAMETER                                | CONDITIONS   | MIN. | TYP. | MAX. | UNIT |
|-----------------------------------|--|--|------|------|------|------|
| V <sub>DDA1</sub>                 | analog supply voltage 1 (+5 V; pin 5)    | note 1   | 4.5  | 5.0  | 5.5  | V    |
|                                   |  | operating range  | 4.75 | 5.0  | 5.25 | V    |
| I <sub>DDA1</sub>                 | analog supply current 1 (pin 5)          | FM mode  | 17   | 21   | 25   | mA   |
|                                   |  | AM mode  | 14   | 17   | 21   | mA   |
| I <sub>19</sub> + I <sub>20</sub> | total FM mixer output current            |  | 4.8  | 6.0  | 7.2  | mA   |
| I <sub>22</sub> + I <sub>23</sub> | total AM mixer output current            |  | 10   | 12   | 14   | mA   |
| V <sub>DDA2</sub>                 | analog supply voltage 2 (pin 28)         | note 1   | 7.0  | 8.5  | 10   | V    |
|                                   |  | operating range  | 8.1  | 8.5  | 8.9  | V    |
| I <sub>DDA2</sub>                 | analog supply current 2 (pin 28)         | FM mode  | 2.4  | 3.0  | 3.6  | mA   |
| V <sub>DDA3</sub>                 | analog supply voltage 3 (+8.5 V; pin 56) | note 1   | 7.0  | 8.5  | 10   | V    |
|                                   |  | operating range  | 8.1  | 8.5  | 8.9  | V    |
| I <sub>DDA3</sub>                 | analog supply current 3 (pin 56)         | FM mode  | 19   | 24   | 28   | mA   |
|                                   |  | AM mode  | 9.5  | 12   | 15   | mA   |
| V <sub>DDD</sub>                  | digital supply voltage 1 (+5 V; pin 52)  | note 1   | 4.5  | 5.0  | 5.5  | V    |
|                                   |  | operating range  | 4.75 | 5.0  | 5.25 | V    |
| I <sub>DDD</sub>                  | digital supply current (pin 52)          | note 1   | 8    | 10   | 12   | mA   |
| $\frac{S + N}{N}$                 | signal plus noise-to-noise ratio         | FM mode;<br>$\Delta f = 22.5$ kHz at<br>pins 43 and 47 | 66   | 75   | –    | dB   |
|                                   |  | AM mode; m = 0.3                                       | 54   | 60   | –    | dB   |
| THD                               | total harmonic distortion                | FM mode; $\Delta f = 75$ kHz                           | –    | 0.1  | 0.35 | %    |
|                                   |  | AM mode  | –    | 1.5  | 3    | %    |
| $\alpha_{cs}$                     | channel separation (adjusted)            |  | 40   | –    | –    | dB   |
| T <sub>amb</sub>                  | operating ambient temperature            |  | –40  | –    | +85  | °C   |

## Note

1. IC is operating; specified parameters may deviate from limits which are valid for operating range.

# In Car Entertainment (ICE) car radio

## TEA6823T, TEA6825T

### BLOCK DIAGRAM

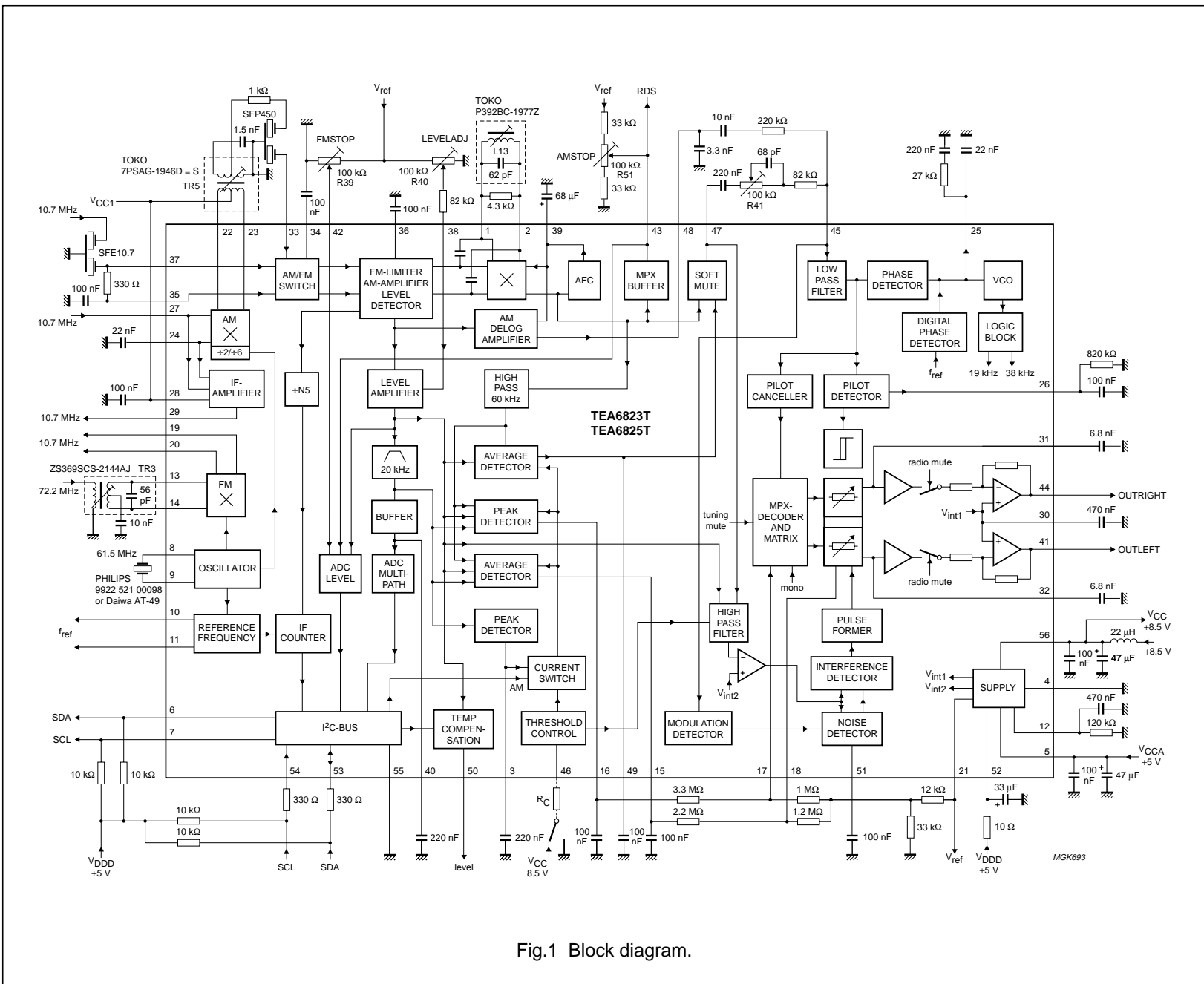

Fig.1 Block diagram.

## In Car Entertainment (ICE) car radio

## TEA6823T; TEA6825T

## PINNING

| SYMBOL              | PIN | DESCRIPTION                           |
|---------------------|-----|---------------------------------------|
| QDET1               | 1   | demodulator tank 1                    |
| QDET2               | 2   | demodulator tank 2                    |
| TSWITCH             | 3   | time switch input                     |
| AGND                | 4   | analog ground                         |
| V <sub>DDA1</sub>   | 5   | analog supply voltage 1 (+5 V)        |
| HFBUS1              | 6   | HF bus 1 output;<br>pull-up to +5 V   |
| HFBUS2              | 7   | HF bus 2 output;<br>pull-up to +5 V   |
| XTAL1               | 8   | crystal oscillator 1                  |
| XTAL2               | 9   | crystal oscillator 2                  |
| f <sub>ref(p)</sub> | 10  | PLL reference frequency<br>output (p) |
| f <sub>ref(n)</sub> | 11  | PLL reference frequency<br>output (n) |
| I <sub>ref</sub>    | 12  | reference current                     |
| FMIF1IN1            | 13  | 72 MHz FM-IF input 1                  |
| FMIF1IN2            | 14  | 72 MHz FM-IF input 2                  |
| TSDR                | 15  | time constant for SDR                 |
| TSDS                | 16  | time constant for SDS                 |
| V <sub>SDS</sub>    | 17  | SDS control voltage input             |
| V <sub>SDR</sub>    | 18  | SDR control voltage input             |
| FMIF2OUT1           | 19  | FM mixer output 1                     |
| FMIF2OUT2           | 20  | FM mixer output 2                     |
| V <sub>ref</sub>    | 21  | reference voltage output              |
| AMIF2OUT1           | 22  | AM mixer output 1                     |
| AMIF2OUT2           | 23  | AM mixer output 2                     |
| FMAMDEC             | 24  | FM/AM 10.7 MHz decoupling             |
| PHASEDET            | 25  | phase detector output                 |
| PILDET              | 26  | pilot detector output                 |
| FMAM10.7            | 27  | FM/AM 10.7 MHz input                  |
| V <sub>DDA2</sub>   | 28  | analog supply voltage 2               |

| SYMBOL                | PIN | DESCRIPTION                                  |
|-----------------------|-----|--|
| FMIFAMPDOUT           | 29  | FM-IF amplifier output                       |
| AFGND                 | 30  | AF ground                                    |
| DEEMPHR               | 31  | de-emphasis capacitor right                  |
| DEEMPHL               | 32  | de-emphasis capacitor left                   |
| AMIF2IN1              | 33  | AM-IF <sub>2</sub> input 1                   |
| AMIF2IN2              | 34  | AM-IF <sub>2</sub> input 2                   |
| FMIN2                 | 35  | FM limiter input                             |
| DCFEED                | 36  | DC feed FM limiter                           |
| FMIN1                 | 37  | FM limiter input                             |
| LEVELADJ              | 38  | level adjustment input                       |
| C <sub>AFC</sub>      | 39  | AFC capacitor                                |
| MPBUF                 | 40  | multi-path buffer time constant              |
| OUTLEFT               | 41  | AF output left                               |
| FMSTOP                | 42  | FMSTOP adjustment input                      |
| RDS/AMSTOP            | 43  | MPX for RDS/AMSTOP<br>adjustment input       |
| OUTRIGHT              | 44  | AF output right                              |
| MPXIN                 | 45  | stereo decoder MPX input                     |
| THRES                 | 46  | threshold                                    |
| MPXOUT                | 47  | FM demodulator MPX output                    |
| AMAFOUT               | 48  | AM demodulator AF output                     |
| V <sub>mute/AML</sub> | 49  | mute voltage/AM level                        |
| LEVELUNWEIG           | 50  | unweighted level output                      |
| IAC <sub>CONTR</sub>  | 51  | IAC control voltage                          |
| V <sub>DDD</sub>      | 52  | digital supply voltage                       |
| SDA                   | 53  | serial data input/output;<br>pull-up to +5 V |
| SCL                   | 54  | serial clock input;<br>pull-up to +5 V       |
| DGND                  | 55  | digital ground                               |
| V <sub>DDA3</sub>     | 56  | analog supply voltage 3<br>(+8.5 V)          |

In Car Entertainment (ICE) car radio

TEA6823T; TEA6825T

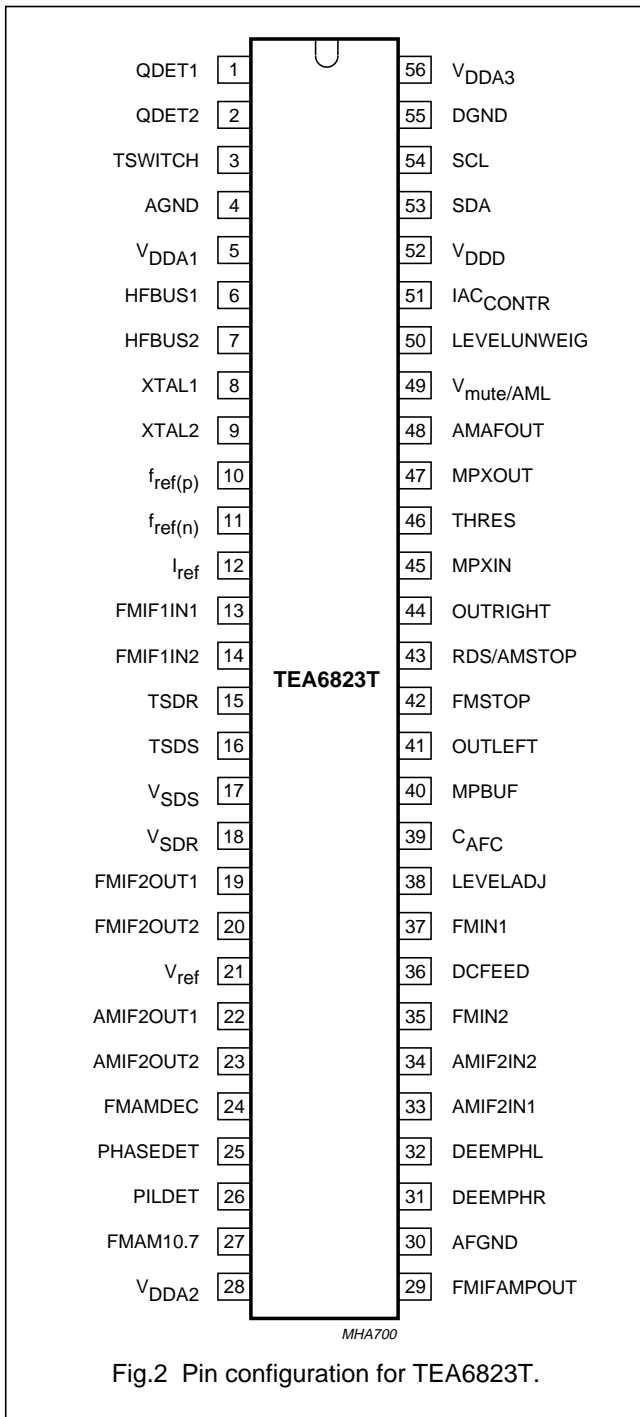

Fig.2 Pin configuration for TEA6823T.

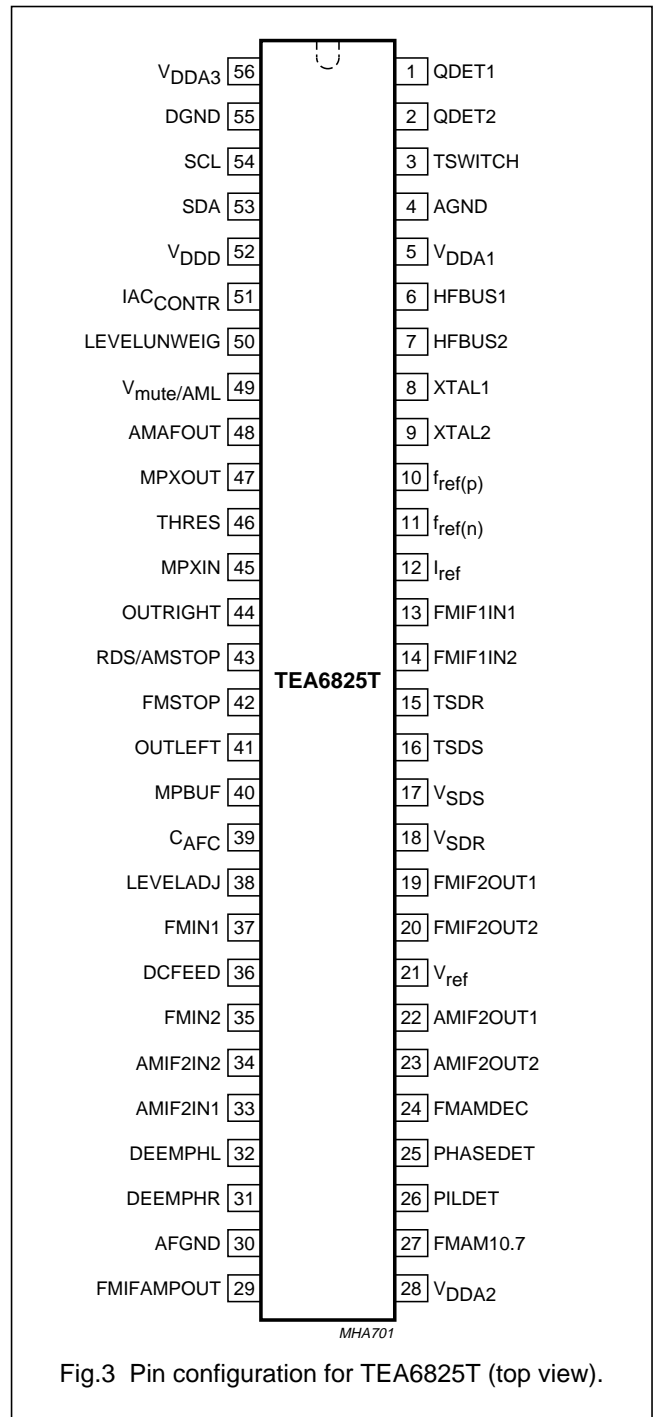

Fig.3 Pin configuration for TEA6825T (top view).

**FUNCTIONAL DESCRIPTION**

**Stereo decoder**

By changing the value of the input resistor at pin 12 the MPX input can be adapted to the level of the FM demodulator output (see Fig.16).

A 3rd order low-pass filter ( $f_g = 90 \text{ kHz}$ ) at the MPX input provides an extra 190 kHz ACI suppression.

An interference gate is connected at the MPX demodulator outputs. For AM the VCO is switched off.

## In Car Entertainment (ICE) car radio

## TEA6823T; TEA6825T

**LIMITING VALUES**

In accordance with the Absolute Maximum Rating System (IEC 134).

| SYMBOL            | PARAMETER                        | CONDITIONS | MIN. | MAX. | UNIT |
|-------------------|----------------------------------|------------|------|------|------|
| V <sub>DDA1</sub> | analog supply voltage 1 (pin 5)  |            | -0.3 | +6.5 | V    |
| V <sub>DDA2</sub> | analog supply voltage 2 (pin 28) |            | -0.3 | +12  | V    |
| V <sub>DDA3</sub> | analog supply voltage 3 (pin 56) |            | -0.3 | +12  | V    |
| V <sub>DDD</sub>  | digital supply voltage (pin 52)  |            | -0.3 | +6.5 | V    |
| T <sub>stg</sub>  | storage temperature              |            | -55  | +150 | °C   |
| T <sub>amb</sub>  | operating ambient temperature    |            | -40  | +85  | °C   |
| V <sub>es</sub>   | electrostatic handling           | note 1     |      |      |      |
|                   | pins 8 and 9                     |            | -100 | +100 | V    |
|                   | all other pins                   |            | -300 | +300 | V    |

**Note**

- Charge device model class B: equivalent to discharging a 200 pF capacitor via a 0 Ω series resistor.

**CHARACTERISTICS**

V<sub>56-4</sub> = V<sub>28-4</sub> = 8.5 V; V<sub>5-4</sub> = V<sub>52-55</sub> = 5 V; T<sub>amb</sub> = 25 °C; f<sub>mod</sub> = 1 kHz; deviation = 22.5 kHz; R<sub>g</sub> = 50 Ω; V<sub>37-35</sub> = 10 mV; with de-emphasis = 50 μs; coil quality = 15; unless otherwise specified.

| SYMBOL                                    | PARAMETER  | CONDITIONS     | MIN. | TYP. | MAX. | UNIT |
|---|--|----------------|------|------|------|------|
| <b>Currents</b>                           |  |                |      |      |      |      |
| I <sub>DDA1</sub>                         | analog supply current 1 (pin 5)                    | FM mode        | 17   | 21   | 25   | mA   |
|   |  | AM mode        | 14   | 17   | 21   | mA   |
| I <sub>DDA2</sub>                         | analog supply current 2 (pin 28)                   | FM mode        | 2.4  | 3.0  | 3.6  | mA   |
| I <sub>DDA3</sub>                         | analog supply current 3 (pin 56)                   | FM mode        | 19   | 24   | 28   | mA   |
|   |  | AM mode        | 9.5  | 12   | 15   | mA   |
| I <sub>DDD</sub>                          | digital supply current (pin 52)                    |                | 8    | 10   | 12   | mA   |
| I <sub>19</sub> + I <sub>20</sub>         | total FM mixer output current                      |                | 4.8  | 6.0  | 7.2  | mA   |
| I <sub>22</sub> + I <sub>23</sub>         | total AM mixer output current                      | AM mode        | 10   | 12   | 14   | mA   |
| <b>FM-IF path; see Fig.4</b>              |  |                |      |      |      |      |
| V <sub>19-20 max(p-p)</sub>               | maximum output voltage (peak-to-peak value)        |                | 12.0 | 14.0 | –    | V    |
| I <sub>19</sub> ; I <sub>20</sub>         | mixer bias current                                 |                | 2.4  | 3.0  | 3.6  | mA   |
|   | mixer leakage current                              | in AM position | –    | –    | 2    | μA   |
| I <sub>19IF2</sub> /V <sub>13-14IF1</sub> | conversion gain                                    |                | 1.65 | 1.9  | 2.2  | mS   |
| R <sub>i</sub>                            | input resistance (pins 13 to 14)                   |                | 5    | 7    | –    | kΩ   |
| C <sub>i</sub>                            | input capacitance (pins 13 to 14)                  |                | –    | 3    | 4.5  | pF   |
| R <sub>opt</sub>                          | optimum generator resistance                       |                | –    | 1.2  | –    | kΩ   |
| R <sub>o</sub>                            | output resistance (pins 19 to 20)                  |                | 15   | 20   | –    | kΩ   |
| C <sub>o</sub>                            | output capacitance (pins 19 to 4 and pins 20 to 4) |                | –    | 12   | 14   | pF   |
| IP3                                       | third order intermodulation                        |                | 114  | 124  | –    | dBμV |

## In Car Entertainment (ICE) car radio

## TEA6823T; TEA6825T

| SYMBOL                             | PARAMETER  | CONDITIONS  | MIN. | TYP.                | MAX. | UNIT            |
|------------------------------------|--|---|------|---------------------|------|-----------------|
| <b>Oscillator</b>                  |  |   |      |                     |      |                 |
| $f_{osc}$                          | oscillator frequency   |   | –    | 61.5                | –    | MHz             |
| $\Delta f_{osc}$                   | oscillator frequency spread                                  |   | –    | –                   | 250  | Hz              |
| $\Delta f_{osc}/\Delta T$          | temperature dependence of oscillator frequency               | crystal type Philips 9922 521 00098                                 | –    | $30 \times 10^{-6}$ | –    | K <sup>-1</sup> |
| $R_1$                              | crystal motional resistance                                  |   | –    | –                   | 70   | $\Omega$        |
| $C_0$                              | crystal shunt capacitance                                    |   | –    | –                   | 5    | pF              |
| <b>FM-IF<sub>2</sub> amplifier</b> |  |   |      |                     |      |                 |
| $V_{27-24 \max(rms)}$              | maximum input voltage for 1 dB compression point (RMS value) |   | 80   | 110                 | –    | mV              |
| $V_{29-4 \max(rms)}$               | maximum output voltage (RMS value)                           |   | 220  | 320                 | –    | mV              |
| $V_{29-4}/V_{27-24}$               | amplifier gain   | $R_L = 330 \Omega$ ; see Fig.5                                      | 9    | 12                  | 15   | dB              |
| $\Delta V_{29-4}/V_{27-24}$        | gain temperature dependence                                  | $-25 \text{ }^\circ\text{C} < T_{amb} < +85 \text{ }^\circ\text{C}$ | –    | 0.1                 | –    | dB/K            |
| $R_i$                              | input resistance (pins 27 to 24)                             |   | 300  | 330                 | 360  | $\Omega$        |
| $C_i$                              | input capacitance (pins 27 to 4)                             |   | –    | –                   | 5    | pF              |
| $R_o$                              | output resistance (pin 29)                                   |   | 300  | 330                 | 360  | $\Omega$        |
| $C_o$                              | output capacitance (pins 29 to 4)                            |   | –    | –                   | 5    | pF              |
| <b>FM-IF<sub>2</sub> limiter</b>   |  |   |      |                     |      |                 |
| $V_{o \ 1-2(p-p)}$                 | limiter output voltage (peak-to-peak value)                  |   | 500  | 700                 | –    | mV              |
| $V_{1-2}/V_{37-35}$                | limiter gain   | see Fig.6   | –    | 80                  | –    | dB              |
| $C_i$                              | input capacitance (pins 37 to 4)                             |   | –    | –                   | 5    | pF              |
| $R_o$                              | output resistance (pins 1 to 2)                              |   | –    | –                   | 1.0  | k $\Omega$      |
| $C_o$                              | output capacitance (pins 1 to 2)                             |   | 10   | 15                  | 20   | pF              |



## In Car Entertainment (ICE) car radio

## TEA6823T; TEA6825T

| SYMBOL   | PARAMETER  | CONDITIONS  | MIN. | TYP. | MAX. | UNIT       |
|--|--|---|------|------|------|------------|
| <b>FM demodulator</b>                                |  |   |      |      |      |            |
| $V_{47-4(rms)}$                                      | MPX output voltage (RMS value)                                 |   | 160  | 200  | 240  | mV         |
| $V_{43-4(rms)}$                                      | MPX output voltage for RDS (RMS value)                         |   | 160  | 200  | 240  | mV         |
| $V_{37-35(rms)}$                                     | start of limiting voltage (RMS value)                          | $\alpha_{AF} = -3$ dB   | –    | 25   | 40   | $\mu$ V    |
| $V_{37-35(rms)}$                                     | input voltage for signal plus noise-to-noise ratio (RMS value) | see Fig.7 for pin 47 (MPXOUT) and Fig.8 for pin 43 (RDS/AMSTOP)<br><br>$\frac{S+N}{N} = 26$ dB<br><br>$\frac{S+N}{N} = 46$ dB   | –    | 30   | 45   | $\mu$ V    |
| $\Delta V_{43DC}$                                    | residual DC-offset voltage                                     | $\Delta L_{demod} =$ typical value  | –    | 100  | 1000 | mV         |
|  |  | $10 \mu V < V_{37-35} < 80 \mu V$<br>$80 \mu V < V_{37-35} < 800$ mV  | –    | 10   | 30   | mV         |
| $V_{43FM}/V_{43AM}$                                  | AM suppression   | $\Delta f = 22.5$ kHz;<br>$f_{modAM} = 1$ kHz;<br>$m_{AM} = 30\%$ ;<br>$V_{37-35} = 3$ to 300 mV  | 50   | 60   | –    | dB         |
| $V_{47FM}/V_{47AM}$                                  | AM suppression   | $V_{37-35} = 1$ to 300 mV   | 50   | 60   | –    | dB         |
| $\Delta V_{43-44AFCdis} / \Delta V_{43-44AFCactive}$ | demodulator frequency control voltage (AFC) efficiency         | at 100 kHz detune from exact tuning   | 28   | 32   | –    | dB         |
| $R_o$  | output resistance (pin 47)                                     |   | –    | –    | 3    | k $\Omega$ |
|  | output resistance (pin 43)                                     |   | –    | –    | 1.5  | k $\Omega$ |
|  | AF bandwidth (pin 43)  |   | 200  | –    | –    | kHz        |
| $\frac{S+N}{N}$                                      | signal plus noise-to-noise ratio                               |   | 66   | 75   | –    | dB         |
| THD  | total harmonic distortion                                      | detuning $\leq 50$ kHz;<br>$\Delta f = 75$ kHz; $f_{mod} = 1$ kHz<br>without de-emphasis;<br>$L_{demod} =$ typical value<br>pin 43;<br>$V_{37-35} = 300 \mu V$<br>to 800 mV | –    | 0.1  | 0.35 | %          |
|  |  | pin 47;<br>$V_{37-35} = 1$ to 800 mV  | –    | 0.1  | 0.35 | %          |

## In Car Entertainment (ICE) car radio

## TEA6823T; TEA6825T

| SYMBOL  | PARAMETER                         | CONDITIONS   | MIN.        | TYP.        | MAX.        | UNIT               |
|---|-----------------------------------|--|-------------|-------------|-------------|--------------------|
| <b>Unweighted voltage level</b>   |                                   |  |             |             |             |                    |
| $V_{50-4}$  | unweighted voltage level          | see Fig.9; $V_{38} = 2.52 \text{ V}$<br>$V_{37-35} \leq 2.5 \mu\text{V}$<br>$V_{37-35} = 1.0 \text{ mV}$               | 1.6<br>2.7  | 2.2<br>3.4  | 3.0<br>4.7  | V<br>V             |
| $\Delta V_{50-4}/\Delta V_{37-35}$  | slope of unweighted voltage level | $100 \mu\text{V (RMS)} \leq V_{37-35} < 300 \text{ mV}$<br>temperature compensation off<br>temperature compensation on | 0.75<br>0.6 | 0.9<br>0.75 | 1.05<br>0.9 | V/20 dB<br>V/20 dB |
| $\Delta V_{50-4}/\text{VK}$   | temperature dependence            | $V_{37-35} = 1 \text{ mV}$<br>temperature compensation off<br>temperature compensation on                              | –<br>–      | 5.0<br>2.0  | –<br>–      | mV/VK<br>mV/VK     |
| $I_{50(\text{max})\text{source}}$   | maximum output source current     |  | 0.3         | –           | –           | mA                 |
| $I_{50(\text{max})\text{sink}}$   | maximum output sink current       |  | –50         | –           | –           | $\mu\text{A}$      |
| $R_{o50}$   | output resistance                 |  | –           | –           | 300         | $\Omega$           |
| <b>ADJUSTMENT OF UNWEIGHTED VOLTAGE LEVEL AND <math>V_{\text{mute/AML}}</math>; note 1</b>  |                                   |  |             |             |             |                    |
| $\Delta V_{50}$   | adjusting range voltage           | $V_{37-35} = 10 \text{ mV (RMS)}$  | –1.8        | –           | +1.8        | V                  |
| $V_{38-4}$  | internal bias voltage             |  | –           | 2.6         | –           | V                  |
| $\Delta V_{50-4}/\Delta V_{38-4}$   | adjusting gain                    |  | –           | –0.9        | –           | –                  |
| $R_{i38}$   | input resistance                  |  | –           | 80          | –           | k $\Omega$         |
| <b>MUTING DEPENDENCE ON ADJUST OF LEVEL UNWEIGHTED VOLTAGE; note 2</b>                      |                                   |  |             |             |             |                    |
| $V_{43}/V_{47}$   | start of mute                     | $V_{49}/V_{21} = 0.625$  | 1           | 3           | 7           | dB                 |
| $\frac{\Delta V_{43}/V_{47}}{\Delta V_{49}}$  | mute slope                        | $V_{43}/V_{47} = -6 \text{ dB}$  | –           | 25          | –           | dB/V               |
| <b>Soft mute, time constant control, mono/stereo blend and high-cut control; see Fig.22</b> |                                   |  |             |             |             |                    |
| <b>MUTE VOLTAGE; note 3</b>   |                                   |  |             |             |             |                    |
| $V_{49-4}$  | mute voltage                      | $V_{38} = 2.52 \text{ V}$<br>$V_{37-35} < 2.5 \mu\text{V}$<br>$V_{37-35} = 1.0 \text{ mV}$                             | 1.8<br>2.7  | 2.2<br>3.4  | 3.2<br>4.7  | V<br>V             |
| $\Delta V_{49-4}/\Delta V_{37-35}$  | slope of mute voltage             | $100 \mu\text{V (RMS)} \leq V_{37-35} < 300 \text{ mV}$  | 0.75        | 0.9         | 1.05        | V/20 dB            |
| $\Delta V_{49-4}/\text{VK}$   | temperature dependency            | $V_{37-35} = 1 \text{ mV}$   | –           | 5.0         | –           | mV/VK              |

## In Car Entertainment (ICE) car radio

## TEA6823T; TEA6825T

| SYMBOL  | PARAMETER   | CONDITIONS   | MIN. | TYP. | MAX. | UNIT          |
|---|---|--|------|------|------|---------------|
| ATTACK AND DECAY TIME FOR MUTE VOLTAGE              |   |  |      |      |      |               |
| $I_{ch}$  | charge current  | pin 3 connected to GND   | –    | 3.5  | –    | $\mu\text{A}$ |
|   |   | pin 3 connected to pin 5   | –    | 150  | –    | $\mu\text{A}$ |
| $I_{dch}$   | discharge current                                     | pin 3 connected to GND   | –    | –4.0 | –    | $\mu\text{A}$ |
|   |   | pin 3 connected to pin 5   | –    | –170 | –    | $\mu\text{A}$ |
| $\Delta f$  | muting activated by 60 kHz FM interference            | $V_{49} < 3 \text{ V}$ ; $V_{37-35} = 3 \text{ mV}$ ;<br>$f_{mod} = 60 \text{ kHz}$<br>pin 3 connected to GND;<br>$V_{43}/V_{47} = 9 \text{ dB}$   | –    | 40   | –    | kHz           |
|   |   | pin 3 connected to pin 5;<br>$V_{43}/V_{47} = 6 \text{ dB}$  | –    | 40   | –    | kHz           |
| $V_{43}/V_{47}$                                     | maximum mute depth by 60 kHz FM interference          | pin 3 connected to GND   | –    | 15   | –    | dB            |
|   |   | pin 3 connected to pin 5   | –    | 10   | –    | dB            |
| TIME CONSTANT FOR MONO/STEREO BLEND VOLTAGE; note 4 |   |  |      |      |      |               |
| $I_{ch}$  | charge current  | $V_{37-35} = 3 \text{ mV}$ ;<br>pin 3 connected to GND   | –    | 0.6  | –    | $\mu\text{A}$ |
|   |   | $V_{37-35} = 3 \text{ mV}$ ;<br>pin 3 connected to pin 5   | –    | 23   | –    | $\mu\text{A}$ |
| $I_{dch}$   | discharge current                                     | $V_{37-35} = 3 \text{ mV}$ ;<br>pin 3 connected to GND   | –    | –17  | –    | $\mu\text{A}$ |
|   |   | $V_{37-35} = 3 \text{ mV}$ ;<br>pin 3 connected to pin 5   | –    | –750 | –    | $\mu\text{A}$ |
| m   | mono/stereo blend activated by 20 kHz AM interference | $V_{16} < 2 \text{ V}$ ; $V_{37-35} = 3 \text{ mV}$ ;<br>$R_{L16} > 50 \text{ M}\Omega$ ;<br>$f_{mod} = 20 \text{ kHz}$ ;<br>data byte 2 bit 5 = 0 |      |      |      |               |
|   |   | pin 3 connected to GND   | –    | 45   | –    | %             |
|   |   | pin 3 connected to pin 5   | –    | 45   | –    | %             |
|   |   | data byte 2 bit 5 = 1  |      |      |      |               |
|   |   | pin 3 connected to GND   | –    | 55   | –    | %             |
|   |   | pin 3 connected to pin 5   | –    | 55   | –    | %             |
| $\Delta f$  | mono/stereo blend activated by 60 kHz FM interference | $V_{16} < 2 \text{ V}$ ; $V_{37-35} = 3 \text{ mV}$ ;<br>$R_{L16} > 50 \text{ M}\Omega$ ;<br>$f_{mod} = 60 \text{ kHz}$                            |      |      |      |               |
|   |   | pin 3 connected to GND   | –    | 50   | –    | kHz           |
|   |   | pin 3 connected to pin 5   | –    | 50   | –    | kHz           |

## In Car Entertainment (ICE) car radio

## TEA6823T; TEA6825T

| SYMBOL   | PARAMETER   | CONDITIONS  | MIN. | TYP. | MAX. | UNIT             |
|--|---|---|------|------|------|------------------|
| TIME CONSTANT FOR HIGH-CUT CONTROL VOLTAGE SDR; note 5 |   |   |      |      |      |                  |
| $I_{ch}$   | charge current  | $V_{37-35} = 3 \text{ mV}$ ;<br>pin 3 connected to GND  | –    | 0.6  | –    | $\mu\text{A}$    |
|  |   | $V_{37-35} = 3 \text{ mV}$ ;<br>pin 3 connected to pin 5  | –    | 41   | –    | $\mu\text{A}$    |
| $I_{dch}$  | discharge current                                       | $V_{37-35} = 3 \text{ mV}$ ;<br>pin 3 connected to GND  | –    | –0.7 | –    | $\mu\text{A}$    |
|  |   | $V_{37-35} = 3 \text{ mV}$ ;<br>pin 3 connected to pin 5  | –    | –44  | –    | $\mu\text{A}$    |
| m  | high-cut control activated<br>by 20 kHz AM interference | $V_{15} < 2 \text{ V}$ ; $V_{37-35} = 3 \text{ mV}$ ;<br>$R_{L15} > 50 \text{ M}\Omega$ ;<br>$f_{mod} = 20 \text{ kHz}$<br>pin 3 connected to GND | –    | 45   | –    | %                |
|  |   | pin 3 connected to pin 5  | –    | 45   | –    | %                |
| $\Delta f$   | high-cut control activated<br>by 60 kHz FM interference | $V_{15} < 2 \text{ V}$ ; $V_{37-35} = 3 \text{ mV}$ ;<br>$R_{L15} > 50 \text{ M}\Omega$ ;<br>$f_{mod} = 60 \text{ kHz}$<br>pin 3 connected to GND | –    | 50   | –    | kHz              |
|  |   | pin 3 connected to pin 5  | –    | 50   | –    | kHz              |
| MULTI-PATH DETECTOR                                    |   |   |      |      |      |                  |
| $f_{MP}$   | multi-path detector band-pass<br>centre frequency       |   | –    | 20   | –    | kHz              |
| $B_{MP}$   | band-pass bandwidth                                     |   | 7.0  | –    | –    | kHz              |
| <b>Reference voltage</b>                               |   |   |      |      |      |                  |
| $V_{21-4}$   | output voltage  | $I_{21} = -1 \text{ mA}$  | 4.5  | 5.1  | 5.7  | V                |
| $\Delta V_{21-4}$                                      | temperature dependence                                  |   | –    | 3.3  | –    | mV/VK            |
| $I_{21}$   | output current  |   | –    | –    | 1    | mA               |
| <b>AM-IF path; see Fig.14 and notes 6 and 7</b>        |   |   |      |      |      |                  |
| $V_{22-23 \text{ max(p-p)}}$                           | maximum output voltage<br>(peak-to-peak value)          |   | 12   | 15   | –    | V                |
| $I_{22}, I_{23}$                                       | mixer bias current                                      |   | 5.0  | 6.0  | 7.0  | mA               |
|  | mixer leakage current                                   | in FM position  | –    | –    | 2    | $\mu\text{A}$    |
| $I_{22}I_{F2}/V_{27-24}I_{F1}$                         | conversion transconductance                             |   | 2.2  | 2.7  | 3.4  | mS               |
| $R_{27-24}$  | input resistance  |   | 300  | 330  | 360  | $\Omega$         |
| $C_{27-24}$  | input capacitance                                       |   | –    | 5    | 8    | pF               |
| $R_{22-23}$  | output resistance                                       |   | 10.0 | 20.0 | –    | k $\Omega$       |
| $C_{22-23}$  | output capacitance                                      |   | –    | 5    | 10   | pF               |
| IP3  | third order intermodulation                             |   | –    | 137  | –    | dB $\mu\text{V}$ |

## In Car Entertainment (ICE) car radio

## TEA6823T; TEA6825T

| SYMBOL                     | PARAMETER  | CONDITIONS  | MIN. | TYP. | MAX. | UNIT          |
|----------------------------|--|---|------|------|------|---------------|
| AM DETECTOR; notes 8 and 9 |  |   |      |      |      |               |
| $V_{48-4(rms)}$            | AF output level (RMS value)                          | $R_{L48} > 500 \text{ k}\Omega$ ;<br>$100 \mu\text{V} \leq V_{33-34} \leq 300 \text{ mV}$ | 190  | 240  | 290  | mV            |
| $V_{33-34(rms)}$           | sensitivity voltage (RMS value)                      | $\frac{S+N}{N} = 26 \text{ dB}$   | –    | 50   | 75   | $\mu\text{V}$ |
|                            |  | $\frac{S+N}{N} = 46 \text{ dB}$   | –    | 200  | 400  | $\mu\text{V}$ |
|                            | AM-IF <sub>2</sub> minimum input voltage (RMS value) | THD $\leq 5\%$ ; $m = 0.8$  | –    | –    | 100  | $\mu\text{V}$ |
|                            | AM-IF <sub>2</sub> maximum input voltage (RMS value) | THD $\leq 5\%$ ; $m = 0.8$  | 800  | –    | –    | mV            |
| $R_{33-34}$                | IF <sub>2</sub> input resistance                     |   | 1.8  | 2.0  | 2.2  | k $\Omega$    |
| $C_{24-23}$                | IF <sub>2</sub> input capacitance                    |   | –    | 10   | 15   | pF            |
| $R_{048}$                  | output resistance                                    |   | 27   | 33   | 39   | k $\Omega$    |
| $C_{048}$                  | output capacitance                                   |   | –    | –    | 10   | pF            |
| $\frac{S+N}{N}$            | signal plus noise-to-noise ratio                     |   | 54   | 60   | –    | dB            |
| THD                        | total harmonic distortion                            | $m = 0.8$ ;<br>$300 \mu\text{V} \leq V_{33-34} \leq 200 \text{ mV}$                       | –    | 1.5  | 3.0  | %             |

**Notes to the characteristics**

- For typical adjusting range see Figs 10 and 13.
- For typical curve see Fig.11.
- The static mute voltage follows the unweighted voltage level as function of FM-IF<sub>2</sub> voltage and level adjustment voltage  $V_{38-4}$ . It additionally depends on multi-path level, noise (adjacent channel interferences) and the position of TSWITCH (pin 3). For typical curve for mute voltage dependence see Fig.12.
- The mono/stereo blend voltage is generated as a function of FM-IF<sub>2</sub> voltage, multi-path level, noise and position of TSWITCH.
- The high-cut control voltage is generated as a function of FM-IF<sub>2</sub> voltage, multi-path level, noise and position of TSWITCH.
- $f_{IF1} = 10.7 \text{ MHz}$ ;  $f_{IF2} = 450 \text{ kHz}$  for AM mixer.
- The AM oscillator signal is generated by division of the 61.5 MHz crystal oscillator. Two divider ratios programmable by the I<sup>2</sup>C-bus: divide by 6 (AM-IF<sub>1</sub> = 10.7 MHz); divide by 2 (AM-IF<sub>1</sub> = 30 MHz).
- For typical AM level curve see Fig.15.
- For AM detector;  $f_{AMIF2} = 450 \text{ kHz}$ ;  $f_{mod} = 400 \text{ Hz}$ ;  $m = 30\%$ .

## In Car Entertainment (ICE) car radio

## TEA6823T; TEA6825T

**STEREO DECODER CHARACTERISTICS**

Input signal ( $\Delta f = 75$  kHz)  $V_{MPX(p-p)} = 1.7$  V;  $f_{mod} = 1$  kHz; de-emphasis time constant  $t = 50$   $\mu$ s; nominal input resistor (pin 45)  $R_i = 168$  k $\Omega$ ;  $T_{amb} = 25$  °C; unless otherwise specified.

| SYMBOL  | PARAMETER                               | CONDITIONS                            | MIN.                                   | TYP. | MAX. | UNIT       |
|---|---|---------------------------------------|--|------|------|------------|
| $V_{44-4(rms)}$ ;<br>$V_{41-4(rms)}$                          | AF output voltage (RMS value)           |                                       | 800                                    | 900  | 1000 | mV         |
| $V_{44-4}$ ; $V_{41-4}$                                       | DC output voltage                       |                                       | 3.1                                    | 3.6  | 4.1  | V          |
| $I_{44(max)}$ ; $I_{41(max)}$                                 | maximum output current                  |                                       | 150                                    | –    | –    | $\mu$ A    |
| $V_{44-4}/V_{41-4}$   | difference of output voltage            |                                       | –1                                     | –    | +1   | dB         |
| $R_{o(44)}$ ; $R_{o(41)}$                                     | output resistance                       |                                       | –                                      | –    | 600  | $\Omega$   |
| $R_{Lmin}$  | minimum load resistor                   |                                       | 12                                     | –    | –    | k $\Omega$ |
| $\alpha_{cs}$   | channel separation (adjusted)           |                                       | 40                                     | –    | –    | dB         |
| $\frac{S+N}{N}$   | signal plus noise-to-noise ratio        | $f = 20$ Hz to 15 kHz                 | 74                                     | 80   | –    | dB         |
| THD   | total harmonic distortion               |                                       | –                                      | 0.1  | 0.3  | %          |
|   | MPX input overdrive margin              | THD = 1%                              | 4                                      | –    | –    | dB         |
| <b>Carrier and harmonic suppression at the output; note 1</b> |   |                                       |  |      |      |            |
| $\alpha_{19}$   | pilot signal                            | $f = 19$ kHz                          | –                                      | 50   | –    | dB         |
| $\alpha_{38}$   | subcarrier                              | $f = 38$ kHz                          | –                                      | 50   | –    | dB         |
| $\alpha_{57}$   |   | $f = 57$ kHz                          | –                                      | 50   | –    | dB         |
| $\alpha_{76}$   |   | $f = 76$ kHz                          | –                                      | 60   | –    | dB         |
| $\alpha_2$  |   | intermodulation                       | $f_{mod} = 10$ kHz; $f_{spur} = 1$ kHz | –    | 60   | –          |
| $\alpha_3$  | $f_{mod} = 13$ kHz; $f_{spur} = 1$ kHz  |                                       | –                                      | 58   | –    | dB         |
| $\alpha_{57}$   | traffic radio (ARI)                     | $f = 57$ kHz                          | –                                      | 70   | –    | dB         |
| $\alpha_{67}$   | subsidiary communications authorization | $f = 67$ kHz                          | 70                                     | –    | –    | dB         |
| $\alpha_{114}$  | adjacent channel frequency              | $f = 114$ kHz                         | –                                      | 80   | –    | dB         |
| $\alpha_{190}$  |   | $f = 190$ kHz                         | –                                      | 70   | –    | dB         |
| RR  | ripple rejection at output              | $f_r = 100$ Hz; $V_r = 100$ mV (eff.) | –                                      | 30   | –    | dB         |
| <b>Mono/stereo control</b>                                    |   |                                       |  |      |      |            |
| $V_{i(pil)}$  | pilot threshold voltage                 | stereo on                             | –                                      | 24   | 30   | mV         |
|   |   | mono on                               | 8                                      | 20   | –    | mV         |
| $\Delta V_{i(pil)}$   | switch hysteresis $V_{i on}/V_{i off}$  |                                       | –                                      | 2    | –    | dB         |
| <b>External mono/stereo control; note 2</b>                   |   |                                       |  |      |      |            |
| $V_{17} - 0.75V_{21}$   | control voltage channel separation      | see Fig.17                            |  |      |      |            |
|   |   | $V_{43}/V_{47} = 6$ dB                | –                                      | –110 | –    | mV         |
|   |   | $V_{43}/V_{47} = 16$ dB               | –                                      | –40  | –    | mV         |

## In Car Entertainment (ICE) car radio

## TEA6823T; TEA6825T

| SYMBOL  | PARAMETER  | CONDITIONS   | MIN.  | TYP.  | MAX.  | UNIT              |
|---|--|--|-------|-------|-------|-------------------|
| <b>Muting functions (mute via I<sup>2</sup>C-bus)</b>   |  |  |       |       |       |                   |
| $\Delta V_{44}, \Delta V_{41}$  | DC offset voltage  | tune mute  | -50   | -     | +50   | mV                |
|   |  | radio mute (in combination with tune mute)                 | -400  | -     | +400  | mV                |
| $\alpha_{\text{mute}}$  | tune mute  |  | 60    | -     | -     | dB                |
|   | radio mute (in combination with tune mute)   |  | 80    | -     | -     | dB                |
| <b>High-cut control; see Fig.18</b>   |  |  |       |       |       |                   |
| $V_{18} - 0.75V_{21}$   | control voltage  | note 3   |       |       |       |                   |
|   |  | $t_{\text{de-emph}} = 50 \mu\text{s}$                      | 0     | -     | -     | mV                |
|   |  | $t_{\text{de-emph}} = 80 \mu\text{s}$                      | -300  | -     | -     | mV                |
| $t_{\text{de-emph}}$  | control range of de-emphasis   |  | 50    | -     | 80    | $\mu\text{s}$     |
| <b>Voltage controlled oscillator; note 4</b>  |  |  |       |       |       |                   |
| $f_{\text{osc}}$  | oscillator frequency   |  | 225   | 228   | 231   | kHz               |
| <b>Noise blanker</b>  |  |  |       |       |       |                   |
| INTERFERENCE DETECTION FULLY INTERNAL FROM LEVEL DETECTOR   |  |  |       |       |       |                   |
| $t_{\text{sup}}$  | interference suppression time  |  | 40    | 50    | -     | $\mu\text{s}$     |
| TRIGGER THRESHOLD CONTROL   |  |  |       |       |       |                   |
| $I_{\text{ch}}$   | charge current (into +4 V)   |  | -     | 45    | -     | $\mu\text{A}$     |
| $I_{\text{dch}}$  | discharge current (from +8.5 V)  |  | -     | -900  | -     | $\mu\text{A}$     |
| TRIGGER SENSITIVITY MEASUREMENT WITH PULSED MODULATION OF FM-IF <sub>2</sub> ; see Figs 19 and 20 |  |  |       |       |       |                   |
| $V_{37-35(p)}$  | trigger sensitivity for test signal 1 (peak value)   | $V_{38} = 2.52 \text{ V}$ ; note 5                         | -     | -     | 0.5   | mV                |
|   |  | $V_{38} = 2.52 \text{ V}$ ; note 6                         | 100   | -     | -     | mV                |
|   | trigger sensitivity for test signal 2 (peak value)   | $V_{38} = 2.52 \text{ V}$ ; note 6                         | 5.0   | -     | -     | mV                |
|   |  | $V_{38} = 2.52 \text{ V}$ ; note 6                         | 100   | -     | -     | mV                |
| $V_{51}$  | trigger threshold variation with frequency modulation of FM-IF <sub>2</sub> and $f_{\text{mod}} = 15 \text{ kHz}$ (pin 51) | $V_{37-35} = 100 \text{ mV}$ ; $\Delta f = 0 \text{ kHz}$  | -     | 6.4   | -     | V                 |
| $\Delta V_{51}$   |  | $V_{37-35} = 100 \text{ mV}$ ; $\Delta f = 40 \text{ kHz}$ | -     | 250   | -     | mV                |
| $V_{37\text{th}}/V_{37(3\text{dB})}$  | shift of threshold for triggering from MPX signal  | $I_{46} = 0$   | 14    | 20    | 26    | dB                |
| $\Delta V_{37\text{th}}/\Delta I_{46}$  | shift of threshold as function of $I_{46}$   |  | -0.32 | -0.25 | -0.16 | dB/ $\mu\text{A}$ |
| $V_{46}$  | bias voltage (pin 46)  | $I_{46} < 0$   | 4.0   | 4.3   | 4.7   | V                 |
|   |  | $I_{46} > 0$   | 5.3   | 5.7   | 6.1   | V                 |
| $I_{\text{offset}}$   | gate input offset current at pins 31 and 32 during suppression pulse duration  |  | -     | 20    | 50    | nA                |

## In Car Entertainment (ICE) car radio

## TEA6823T; TEA6825T

**Notes to the stereo decoder characteristics**

1. The following equations give the values for the carrier and harmonic suppression at the output:

$$\alpha_{27} = \frac{V_0(\text{signal}) (\text{at } 1 \text{ kHz})}{V_0(\text{spurious}) (\text{at } 1 \text{ kHz})} f_s = (2 \times 10 \text{ kHz}) - 19 \text{ kHz}$$

$$\alpha_{33} = \frac{V_0(\text{signal}) (\text{at } 1 \text{ kHz})}{V_0(\text{spurious}) (\text{at } 1 \text{ kHz})} f_s = (3 \times 13 \text{ kHz}) - 38 \text{ kHz}$$

$$\alpha_{57} (\text{ARI}) = \frac{V_0(\text{signal}) (\text{at } 1 \text{ kHz})}{V_0(\text{spurious}) (\text{at } 1 \text{ kHz} \pm 23 \text{ Hz})}$$

$$\alpha_{67} = \frac{V_0(\text{signal}) (\text{at } 1 \text{ kHz})}{V_0(\text{spurious}) (\text{at } 9 \text{ kHz})} f_s = (2 \times 38 \text{ kHz}) - 67 \text{ kHz}$$

$$\alpha_{114} = \frac{V_0(\text{signal}) (\text{at } 1 \text{ kHz})}{V_0(\text{spurious}) (\text{at } 4 \text{ kHz})} f_s = 110 \text{ kHz} - (3 \times 38 \text{ kHz})$$

$$\alpha_{190} = \frac{V_0(\text{signal}) (\text{at } 1 \text{ kHz})}{V_0(\text{spurious}) (\text{at } 4 \text{ kHz})} f_s = 186 \text{ kHz} - (5 \times 38 \text{ kHz})$$

2. The stereo decoder can be set to mono via the I<sup>2</sup>C-bus. Pilot presence indication via the I<sup>2</sup>C-bus.
3. The nominal de-emphasis value can be changed to 75  $\mu\text{s}$  with C<sub>31</sub>; C<sub>32</sub> = 10 nF.
4. The VCO is adjusted by means of a digital auxiliary PLL.
5. Noise blanker does not trigger.
6. Noise blanker triggers.



## In Car Entertainment (ICE) car radio

## TEA6823T; TEA6825T

**CHARACTERISTICS FOR ANALOG-TO-DIGITAL CONVERTERS (ADCs) FOR LEVEL AND MULTI-PATH VOLTAGES**

| SYMBOL  | PARAMETER   | CONDITIONS | MIN. | TYP. | MAX. | UNIT    |
|---|---|------------|------|------|------|---------|
| <b>ADC for FM level information; note 1</b>   |   |            |      |      |      |         |
| $\Delta V_{37-35}$                            | analog-to-digital conversion                      |            |      |      |      |         |
|   | step size   |            | 2    | 4    | 8    | dB/step |
|   | level range                                       |            | 43   | 56   | 69   | dB      |
| <b>FM STOP</b>                                |   |            |      |      |      |         |
| $\Delta V_{\text{stop}}$                      | variation of stop level as function of $V_{42-4}$ |            | –    | 16   | –    | dB/V    |
| <b>ADC for AM level information; note 2</b>   |   |            |      |      |      |         |
| $\Delta V_{33-34}$                            | analog-to-digital conversion step size            |            | 2    | 4    | 8    | dB/step |
| $\Delta V_{33-34}$                            | analog-to-digital conversion level range          |            | 43   | 56   | 69   | dB      |
| <b>AM STOP</b>                                |   |            |      |      |      |         |
| $\Delta V_{\text{stop}}$                      | variation of stop level as function of $V_{43-4}$ |            | –    | 16   | –    | dB/V    |
| <b>ADC for multi-path information; note 3</b> |   |            |      |      |      |         |
| m   | multi-path conversion                             | step 0     | –    | –    | 5    | %       |
|   |   | step 1     | –    | 15   | –    | %       |
|   |   | step 2     | –    | 22   | –    | %       |
|   |   | step 3     | –    | 28   | –    | %       |
|   |   | step 4     | –    | 34   | –    | %       |
|   |   | step 5     | –    | 40   | –    | %       |
|   |   | step 6     | –    | 46   | –    | %       |
|   |   | step 7     | –    | 52   | 60   | %       |

**Notes**

1. The FM level information  $V_{50-3}$  is analog-to-digital converted with 4 bits.
2. The AM level information  $V_{49-4}$  is analog-to-digital converted with 4 bits.
3. The multi-path information  $V_{40-4}$  is analog-to-digital converted with 3 bits covering an  $IF_2$  amplitude modulation range  $m \leq 0.6$ ;  $f_{\text{mod}} = 20$  kHz.

In Car Entertainment (ICE) car radio

TEA6823T; TEA6825T

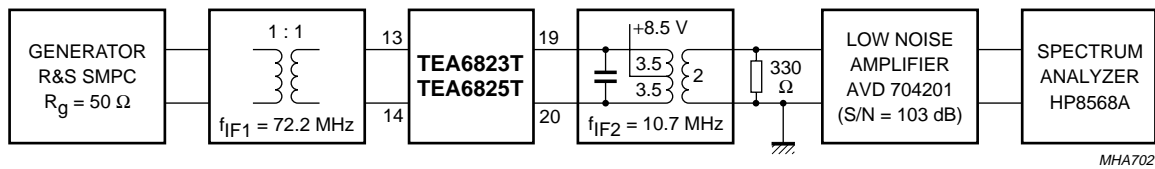

MHA702

Fig.4 Test circuit FM mixer.

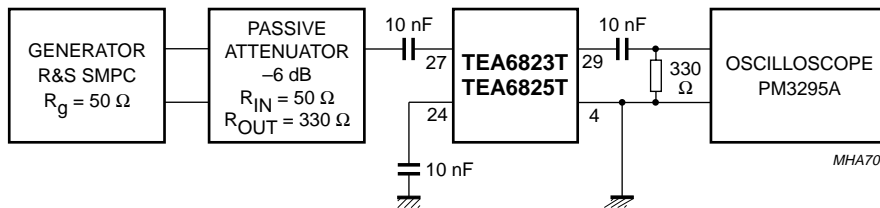

MHA703

Fig.5 Test circuit IF-amplifier.

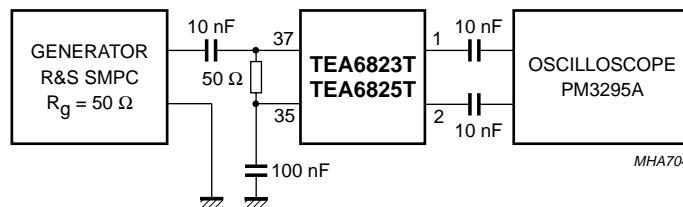

MHA704

Fig.6 Test circuit limiter gain.

In Car Entertainment (ICE) car radio

TEA6823T; TEA6825T

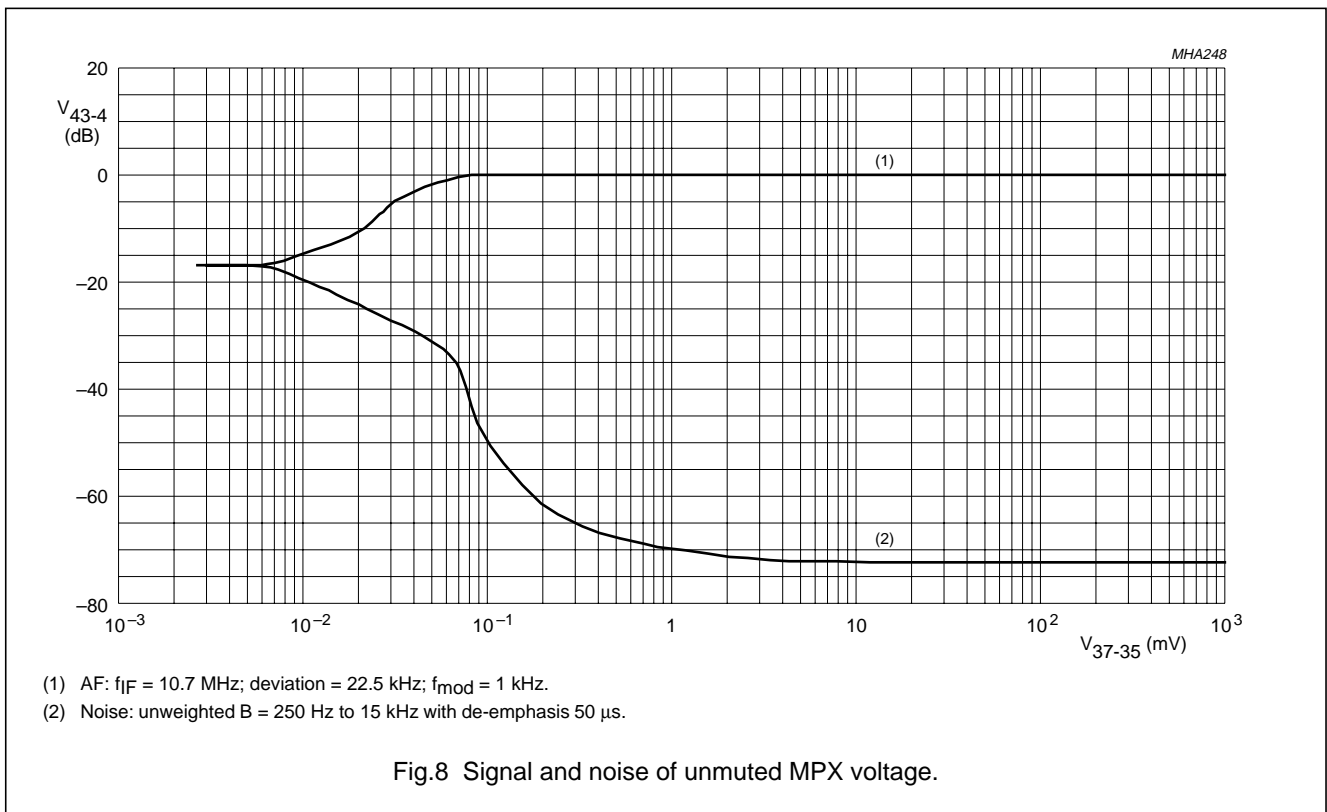
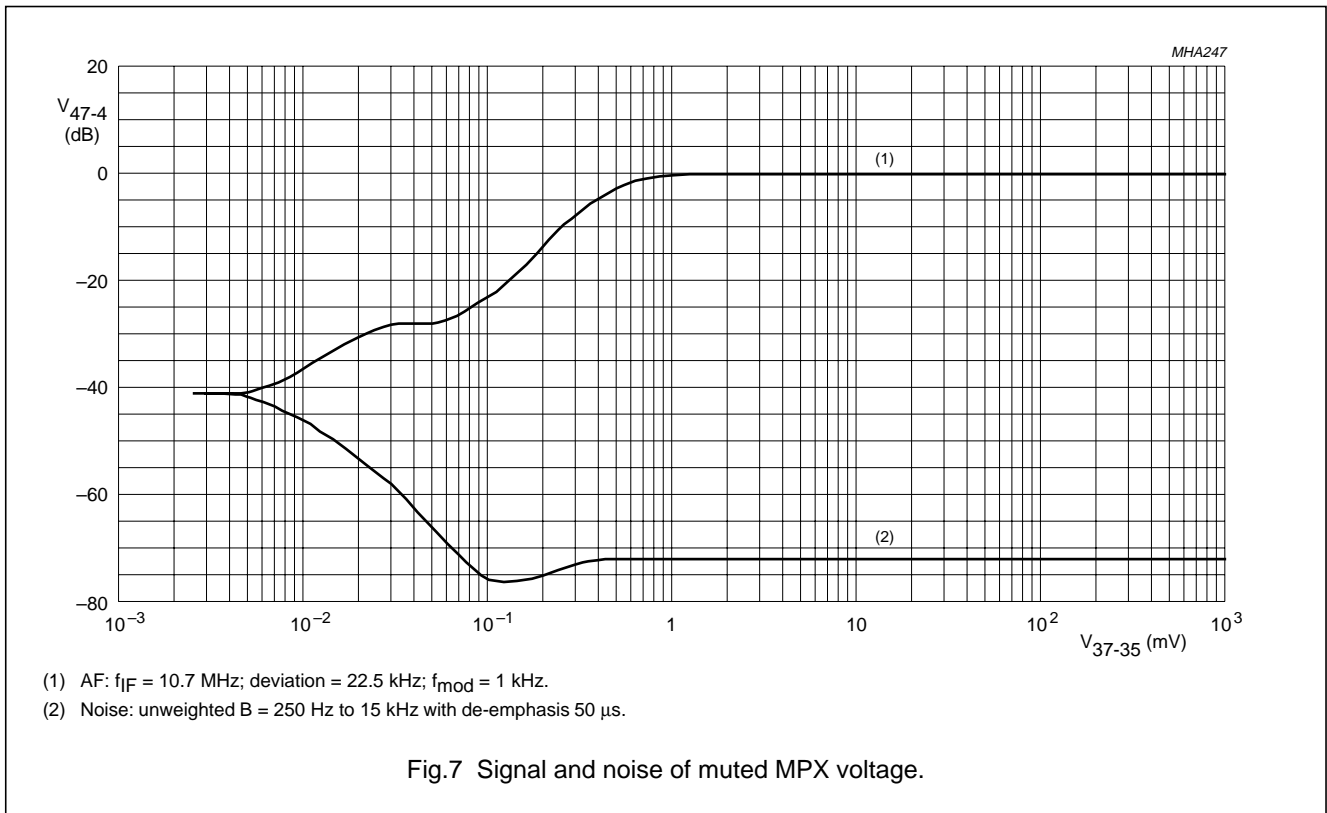

In Car Entertainment (ICE) car radio

TEA6823T; TEA6825T

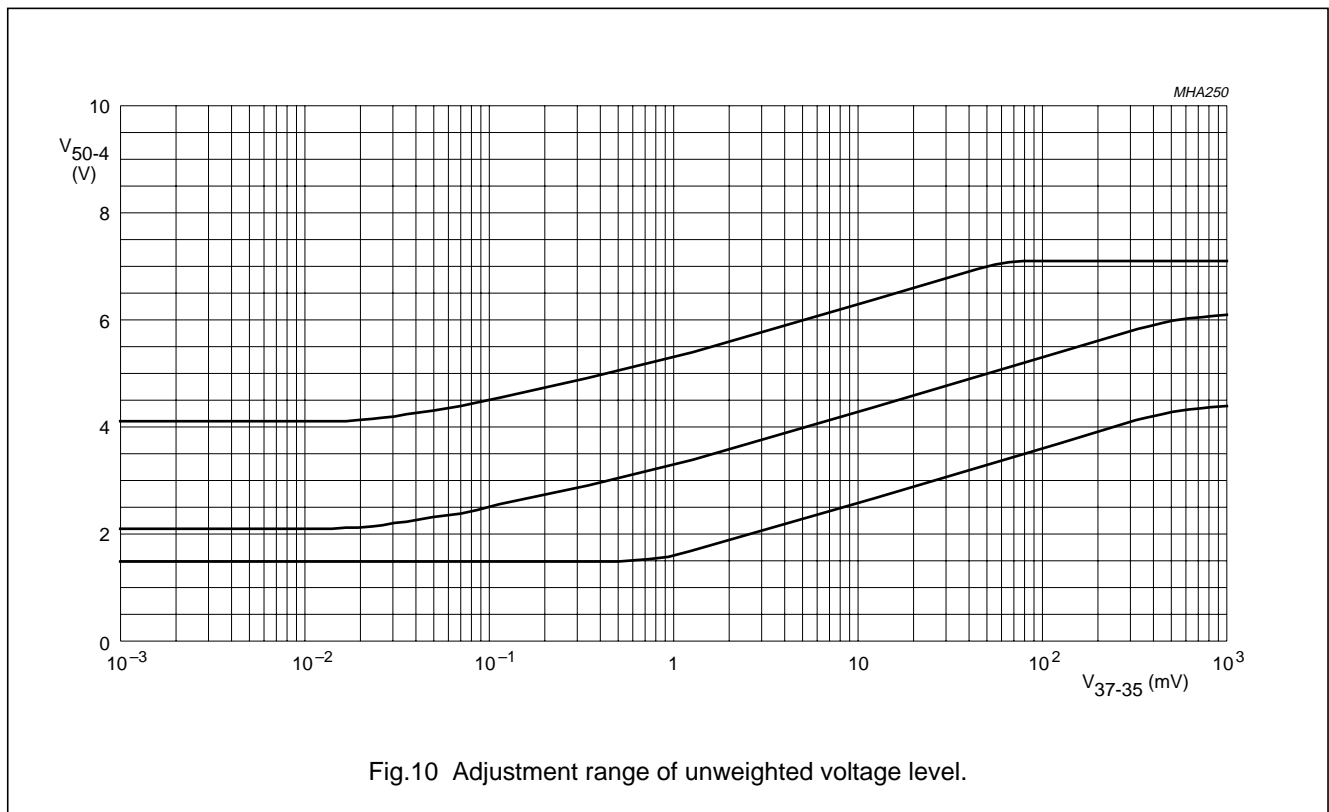
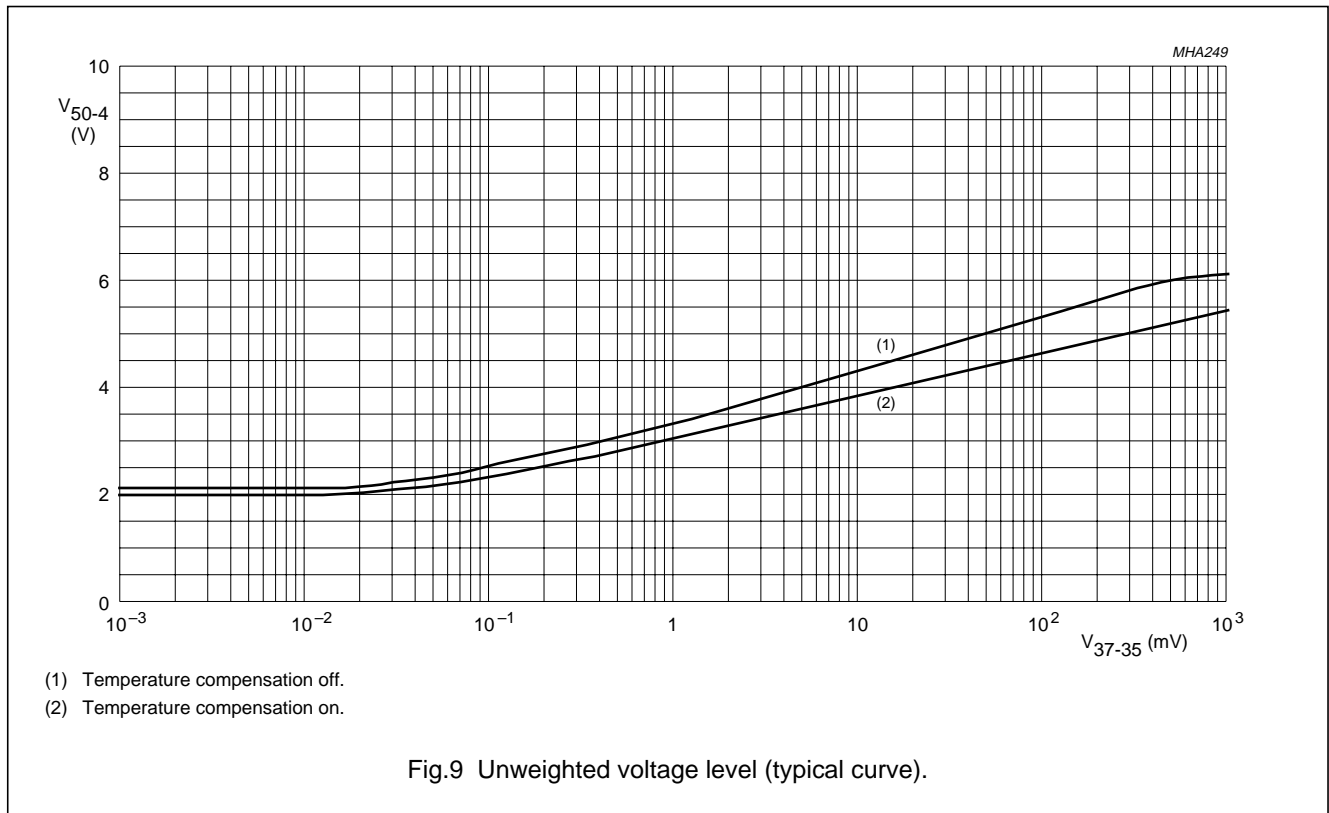

In Car Entertainment (ICE) car radio

TEA6823T; TEA6825T

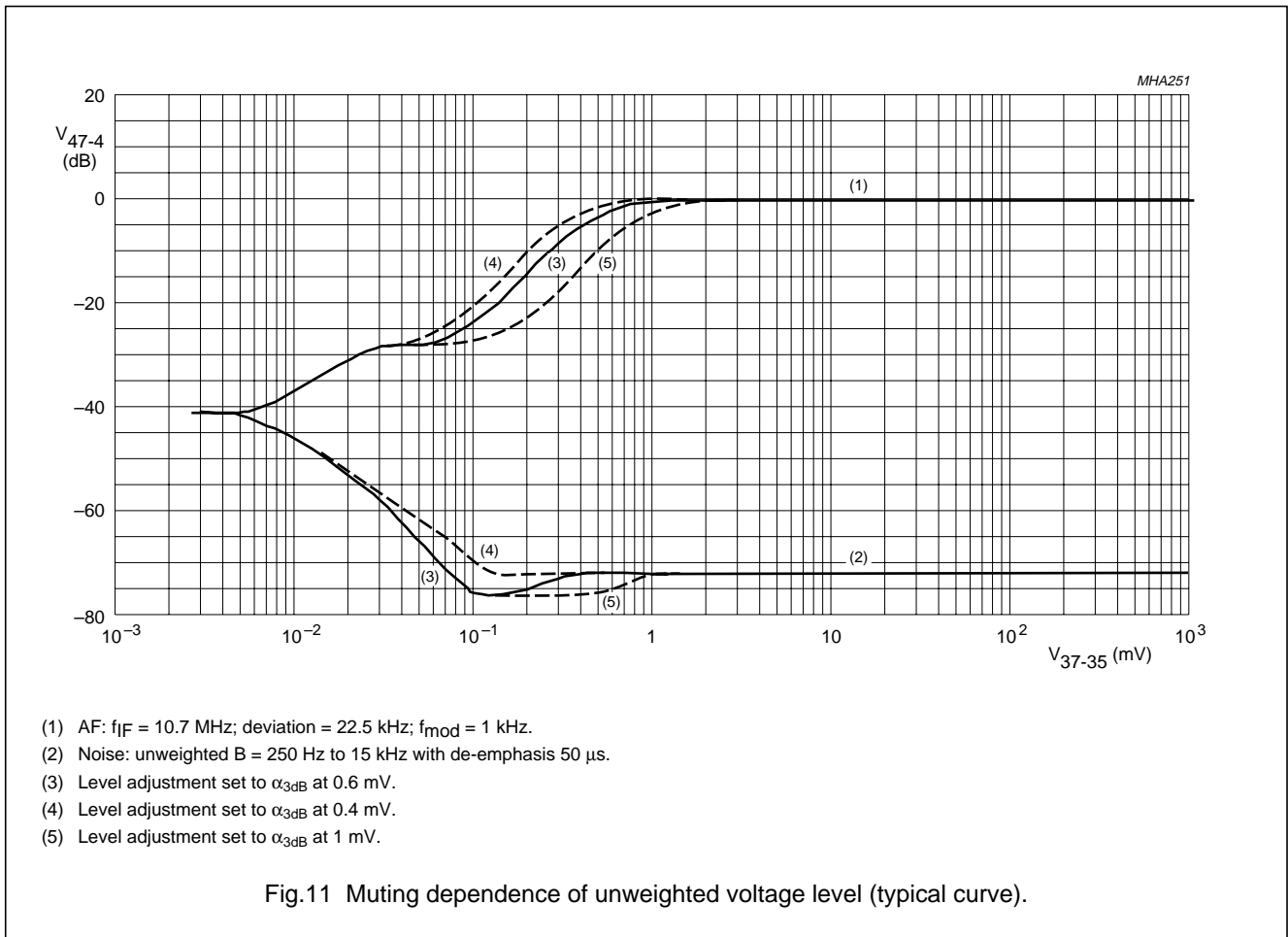

In Car Entertainment (ICE) car radio

TEA6823T; TEA6825T

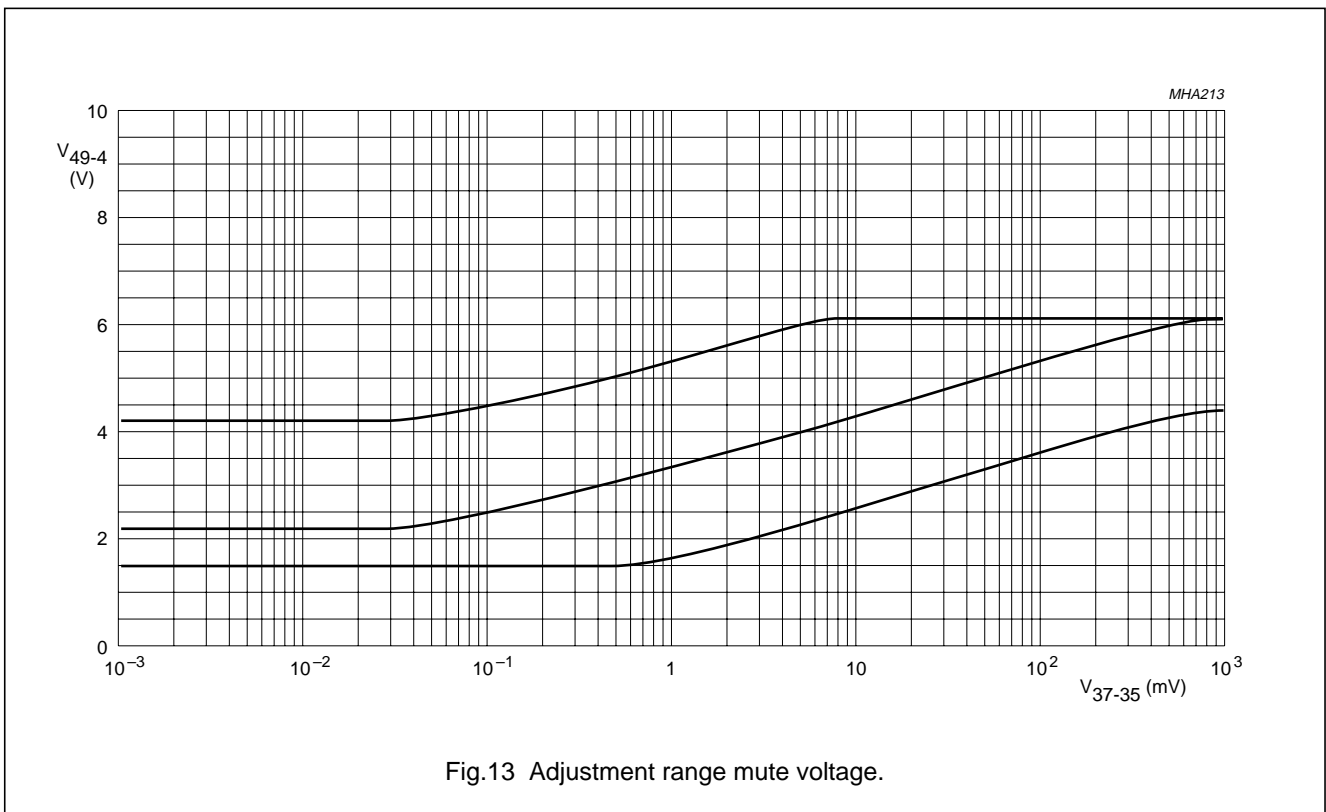
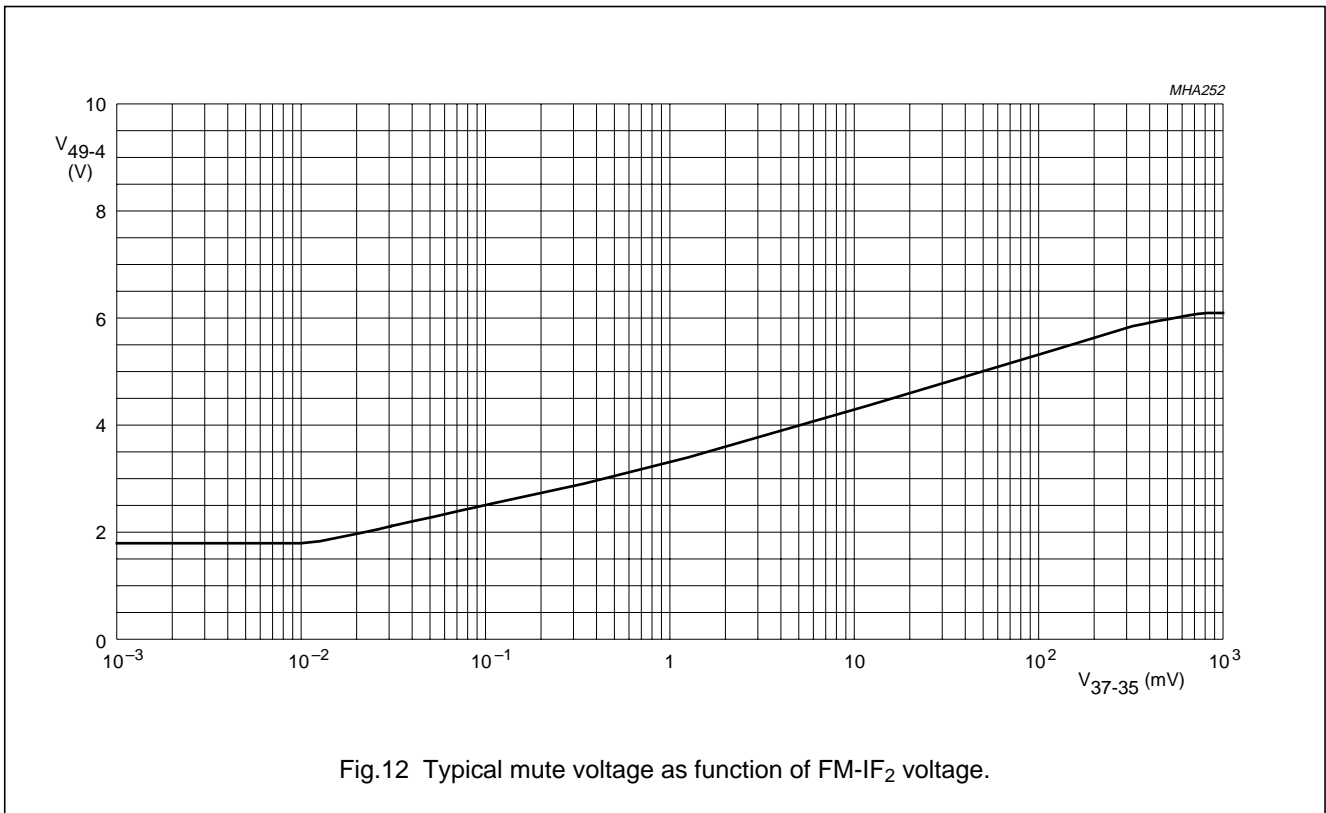

In Car Entertainment (ICE) car radio

TEA6823T; TEA6825T

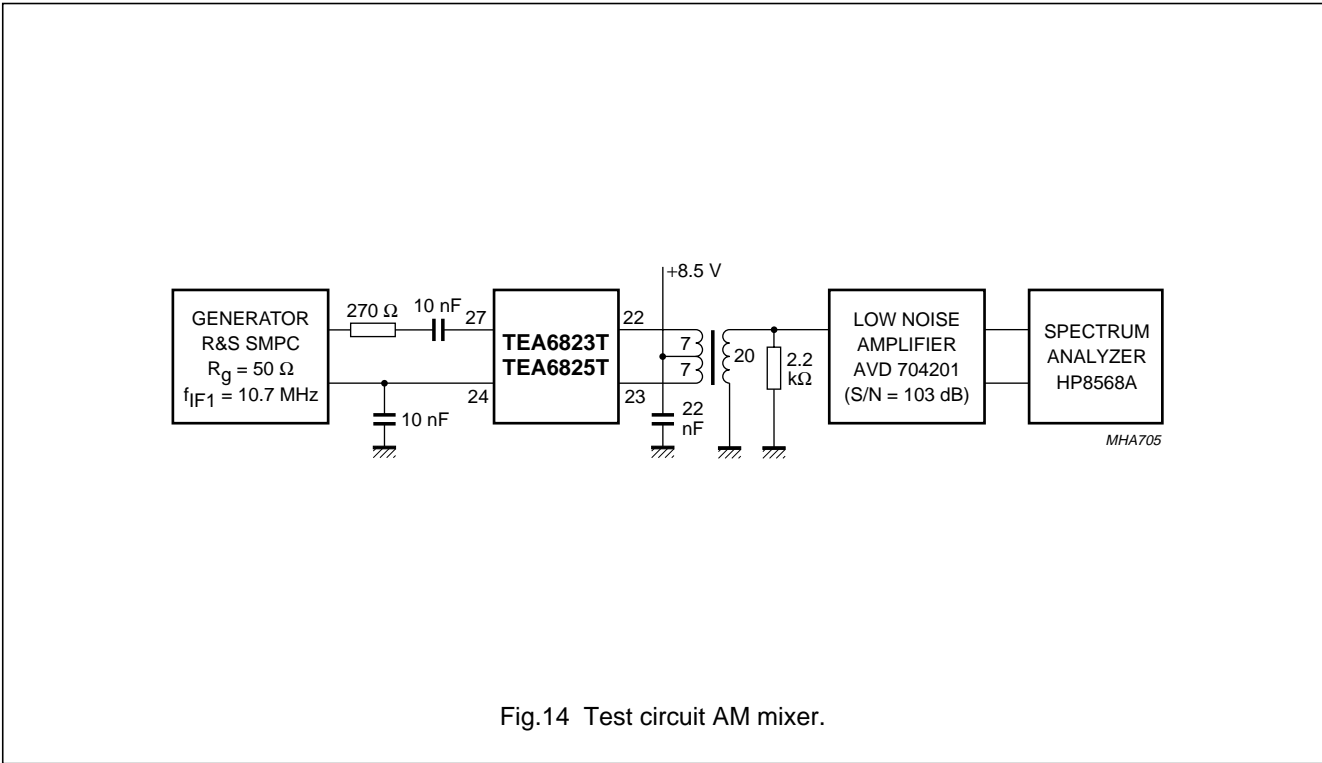

Fig.14 Test circuit AM mixer.

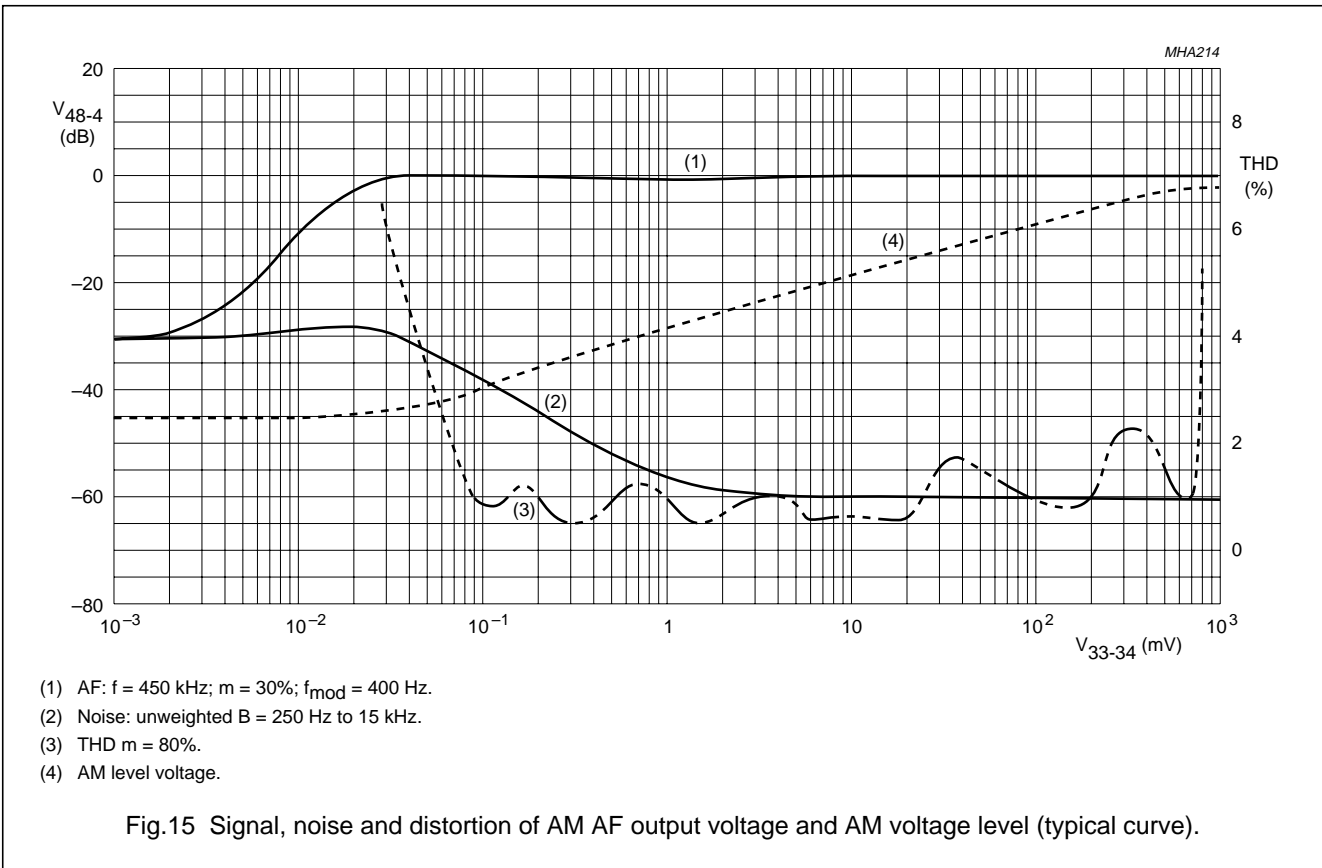
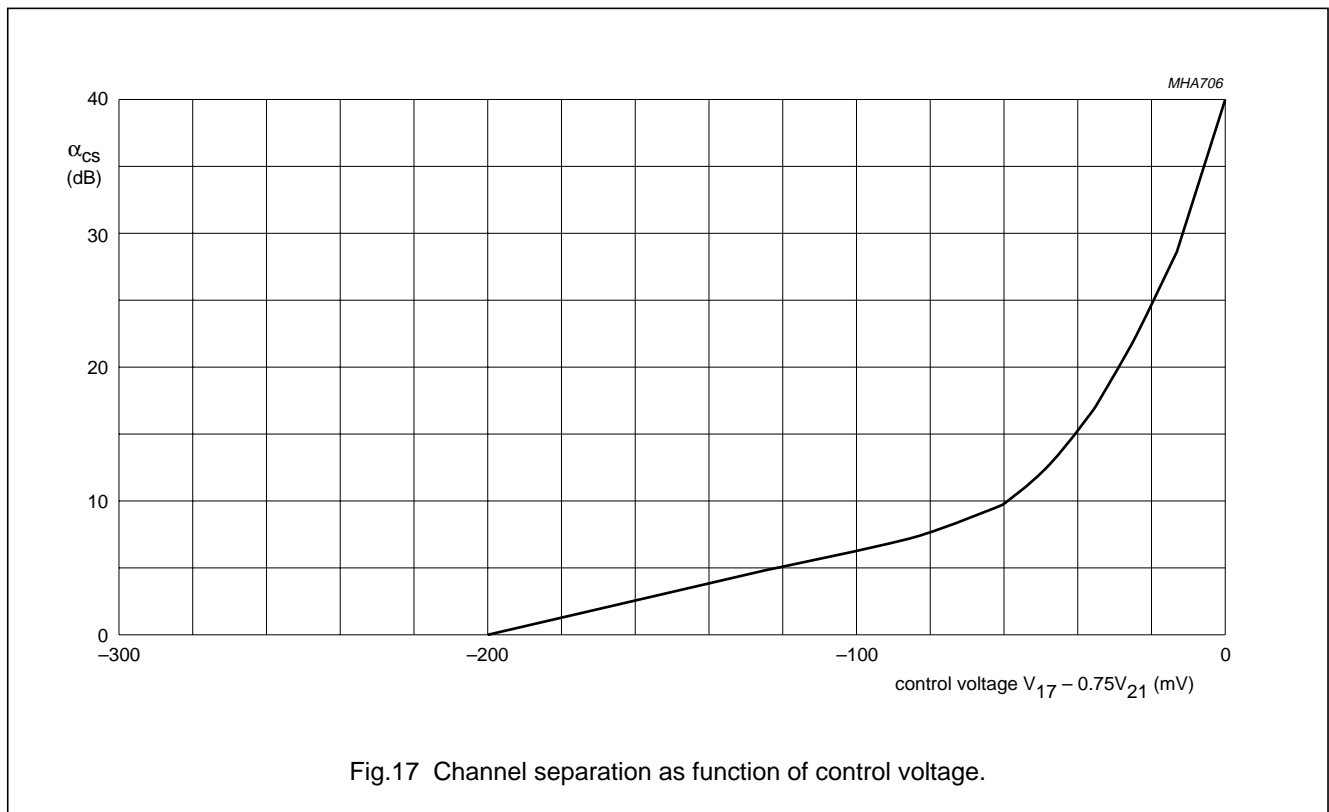
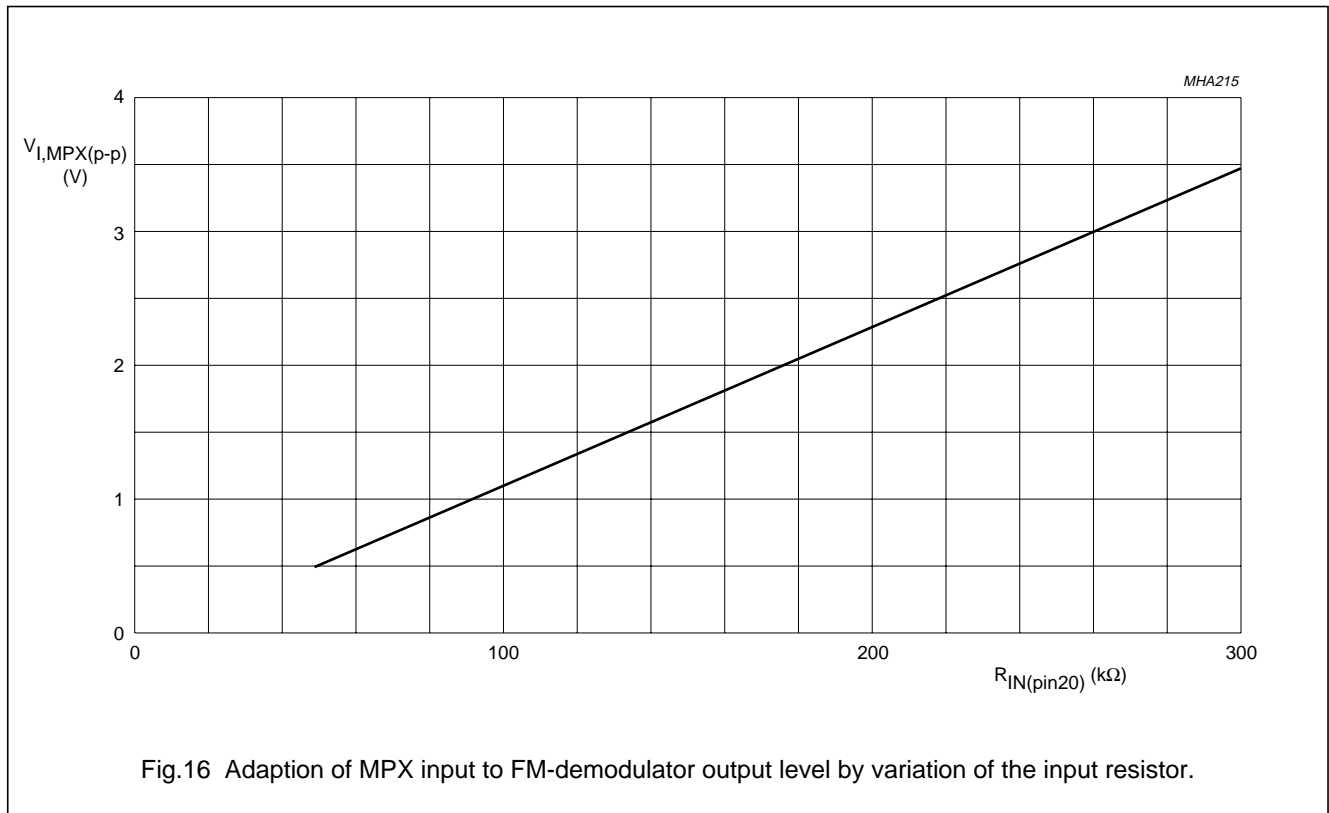

Fig.15 Signal, noise and distortion of AM AF output voltage and AM voltage level (typical curve).

In Car Entertainment (ICE) car radio

TEA6823T; TEA6825T





In Car Entertainment (ICE) car radio

TEA6823T; TEA6825T

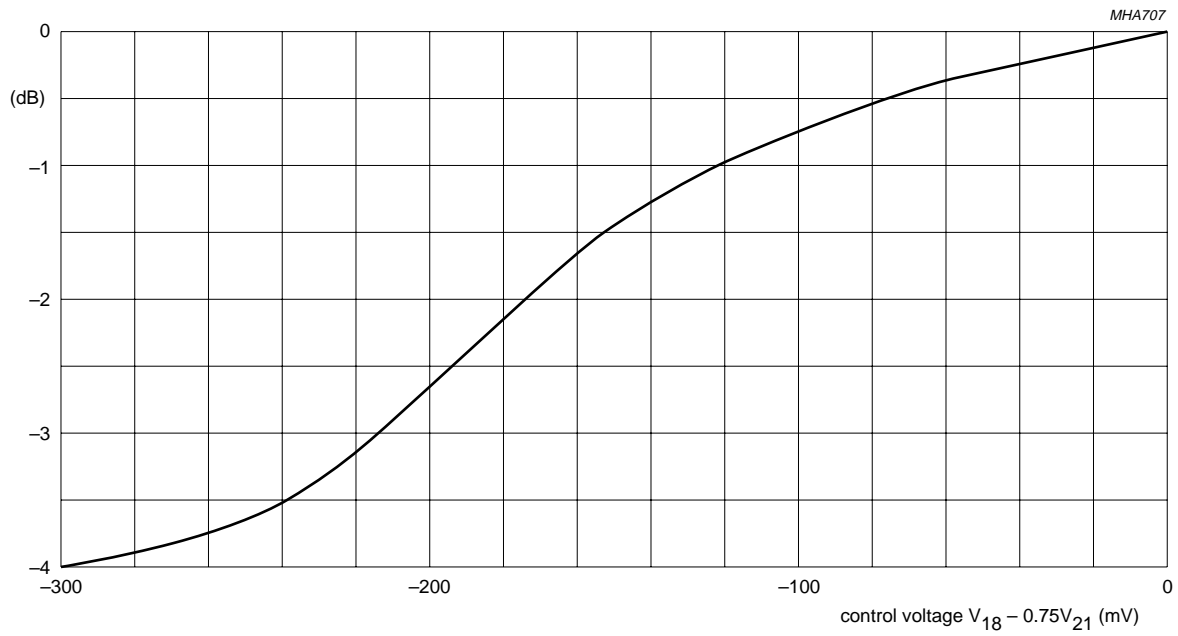
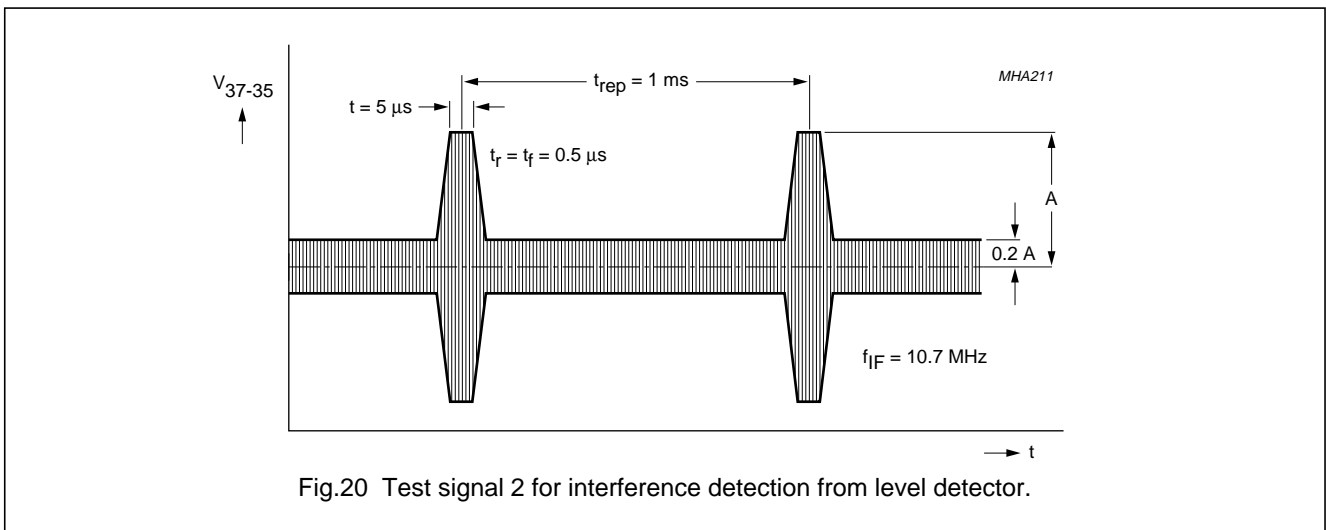
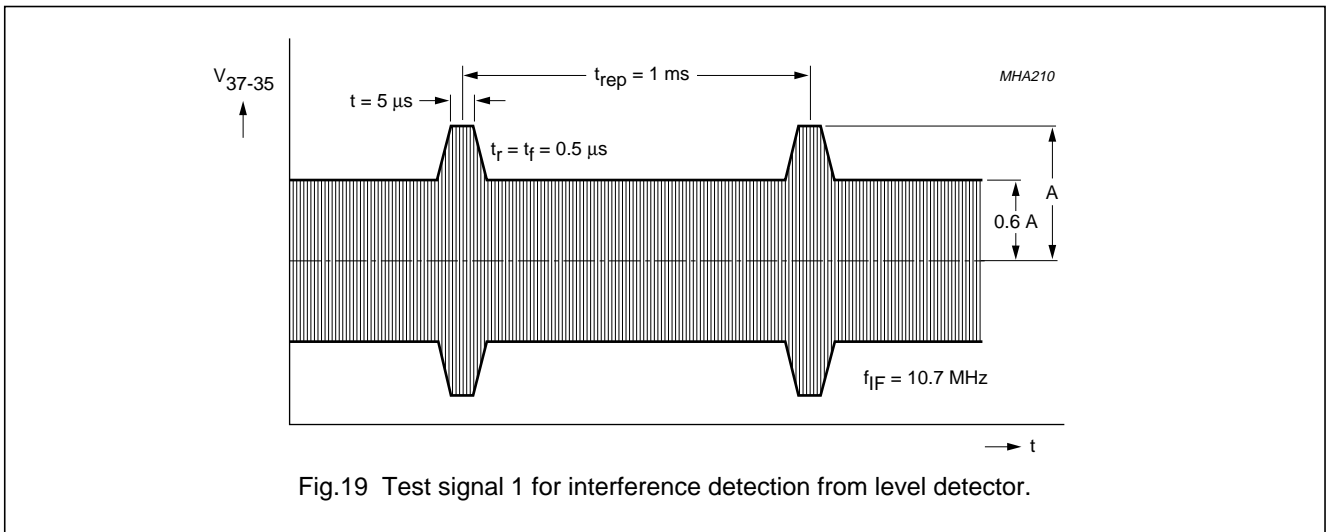

Fig.18 High-cut with  $f_{mod} = 10$  kHz as function of control voltage.

In Car Entertainment (ICE) car radio

TEA6823T; TEA6825T



In Car Entertainment (ICE) car radio

TEA6823T; TEA6825T

**I<sup>2</sup>C-BUS AND I<sup>2</sup>C-BUS CONTROLLED FUNCTIONS**

**I<sup>2</sup>C-bus specification**

The standard I<sup>2</sup>C-bus specification is expanded by the following definitions.

Structure of the I<sup>2</sup>C-bus logic: slave transceiver with auto increment and expansion to switch a direct transfer of all transmissions to an output for the radio front-end IC (TEA6810T respectively TEA6811T).

Subaddresses are not used.

**DATA TRANSFER FOR THE TEA6823T AND THE TEA6825T**

Data sequence:

- Address
- Byte 1
- Byte 2.

The data transfer may be in this order only. The transfer direction of the data bytes is defined by the LSB of the address.

The data becomes valid at the output of the internal latches with the acknowledge of each byte. A STOP condition after any byte can shorten transmission times.

When writing to the transceiver by using the STOP condition before completion of the whole transfer:

- The remaining bytes will contain the old information
- If the transfer of a byte was not completed, this byte is lost and the previous information is available.

**DATA TRANSFER TO AN OUTPUT OF THE FRONT-END IC**

A data bit in the transceiver of the TEA6823T or TEA6825T enables or disables a direct transfer of all transmissions to an interface stage for the front-end IC.

For a transmission to the front-end IC the address and the data format of the front-end IC has to be used.

Remark: the pull-up resistors for the front-end interface (pins 6 and 7) should not be connected to the 5 V supply voltage of the front-end IC, otherwise a bus pull-down (pin 53) can occur during switching off the front-end supply when the interface stage is enabled.

**DATA TRANSFER TO THE IF IC**

Data transfer to the IF IC (TEA6823T or TEA6825T) is independent of the state of interface stage for the front-end IC.

**Table 1** Structure of the I<sup>2</sup>C-bus

| DESCRIPTION                                  | SPECIFICATION   |
|--|---|
| Bus address of the TEA6823T and the TEA6825T | 1100001X  |
| Subaddress                                   | not used  |
| Hardware (pin) programmable address bits     | not available   |
| Default settings by power-on reset           | data byte 1 bits 4 to 7 are set to logic 0; all other bits are random |

**Table 2** Data to be received by the IC for data byte 1

| BIT | DESCRIPTION                                | RESULT    |
|-----|--|-----------|
| 0   | switch for mono                            | bit 0 = 1 |
|     | switch for stereo                          | bit 0 = 0 |
| 1   | LSB reference frequency for synthesizer    |           |
| 2   | reference frequency for synthesizer        |           |
| 3   | MSB reference frequency for synthesizer    |           |
| 4   | tuning mute off                            | bit 4 = 1 |
|     | tuning mute on                             | bit 4 = 0 |
| 5   | SDS/SDR hold off                           | bit 5 = 1 |
|     | SDS/SDR hold on                            | bit 5 = 0 |
| 6   | radio mute off                             | bit 6 = 1 |
|     | radio mute on                              | bit 6 = 0 |
| 7   | I <sup>2</sup> C-bus to front-end ENABLED  | bit 7 = 1 |
|     | I <sup>2</sup> C-bus to front-end DISABLED | bit 7 = 0 |

**Table 3** Reference frequency setting in data byte 1; see Table 1

| BIT 3 | BIT 2 | BIT 1 | FREQUENCY SETTING |
|-------|-------|-------|-------------------|
| 0     | 0     | 0     | 3 kHz             |
| 0     | 0     | 1     | 5 kHz             |
| 0     | 1     | 0     | 10 kHz            |
| 0     | 1     | 1     | 15 kHz            |
| 1     | 0     | 0     | 25 kHz            |
| 1     | 0     | 1     | 50 kHz            |
| 1     | 1     | 0     | not defined       |
| 1     | 1     | 1     | not defined       |

## In Car Entertainment (ICE) car radio

## TEA6823T; TEA6825T

**Table 4** Data to be received by the IC for data byte 2

| BIT | DESCRIPTION  | RESULT    |
|-----|--|-----------|
| 0   | AM/FM; AM mode   | bit 0 = 0 |
|     | AM/FM; FM mode   | bit 0 = 1 |
| 1   | divider for AM mixer; divide by 2  | bit 1 = 0 |
|     | divider for AM mixer; divide by 6  | bit 1 = 1 |
| 2   | measure time IF-count; 40 ms   | bit 2 = 0 |
|     | measure time IF-count; 4 ms  | bit 2 = 1 |
| 3   | SDR off  | bit 3 = 0 |
|     | SDR on   | bit 3 = 1 |
| 4   | IF-prescaler division rate;<br>divide by 200   | bit 4 = 0 |
|     | IF-prescaler division rate;<br>divide by 25  | bit 4 = 1 |
| 5   | sensitivity unchanged  | bit 5 = 0 |
|     | multi-path sensitivity switch; less<br>sensitivity by an offset of $\Delta m = 10\%$   | bit 5 = 1 |
| 6   | temperature compensation of<br>unweighted voltage level;<br>temperature coefficient as specified<br>in Chapter "Characteristics" |           |
|     | temperature compensation off   | bit 6 = 0 |
|     | temperature compensation on  | bit 6 = 1 |
| 7   | noise blanker deactivated by high<br>modulation  | bit 7 = 0 |
|     | noise blanker not deactivated  | bit 7 = 1 |

**Table 5** Data to be transmitted by the IC for data byte 1;  
note 1

| BIT | DESCRIPTION                      |
|-----|----------------------------------|
| 0   | bit 1 level information          |
| 1   | bit 2 level information          |
| 2   | MSB (bit 3) level information    |
| 3   | LSB multi-path information       |
| 4   | multi-path information           |
| 5   | MSB multi-path information       |
| 6   | stereo pilot presence; bit 6 = 1 |
| 7   | LSB (bit 0) level information    |

**Note**

1. The analog-to-digital conversion for multi-path and level will be done during a transmission of any address to the I<sup>2</sup>C-bus.

**Table 6** Data to be transmitted by the IC for data byte 2

| BIT | DESCRIPTION           |
|-----|-----------------------|
| 0   | LSB of the IF-counter |
| 1   | IF-counter            |
| 2   | IF-counter            |
| 3   | IF-counter            |
| 4   | IF-counter            |
| 5   | IF-counter            |
| 6   | IF-counter            |
| 7   | MSB of the IF-counter |

## REFERENCED FREQUENCY GENERATION

**Table 7** Division ratios

| DIVISION RATIO | REFERENCE<br>FREQUENCY<br>(kHz) <sup>(1)</sup> |
|----------------|--|
| 20500          | 3  |
| 12300          | 5  |
| 6150           | 10   |
| 4100           | 15   |
| 2460           | 25   |
| 1230           | 50   |

**Note**

1. All specified frequencies are valid for a crystal oscillator frequency of 61.5 MHz.

In Car Entertainment (ICE) car radio

TEA6823T; TEA6825T

**Table 8** Output signal of reference frequency divider

| SYMBOL                               | PARAMETER  | MIN. | TYP. | MAX. | UNIT     |
|--------------------------------------|--|------|------|------|----------|
| $V_{10-11(p-p)}$                     | differential output voltage (peak-to-peak value) | 0.3  | 0.4  | 0.5  | V        |
| $V_{10-4(p-p)}$ ;<br>$V_{11-4(p-p)}$ | single-ended output voltage (peak-to-peak value) | 0.15 | 0.2  | 0.3  | V        |
| $C_{10-4}$ ; $C_{11-4}$              | output capacitance                               | –    | –    | 4    | pF       |
| $R_{10-52}$ ; $R_{11-52}$            | output resistance                                | 800  | 1000 | 1200 | $\Omega$ |

IF-COUNTER

**Table 9** IF-counter sensitivity

| SYMBOL      | PARAMETER              | CONDITIONS       | MIN. | UNIT    |
|-------------|------------------------|------------------|------|---------|
| $V_{33-34}$ | IF-counter sensitivity | AM mode; $m = 0$ | 200  | $\mu V$ |
| $V_{37-35}$ | IF-counter sensitivity | FM mode          | 200  | $\mu V$ |

AM counting windows are 4 or 40 ms. FM counting windows are 4 or 40 ms. AM counting resolution is 250 or 25 Hz. FM counting resolution is 5 kHz, 625 Hz, 50 kHz or 6.25 kHz. AM-IF-prescaler is divisible by 1. FM-IF-prescaler is divisible by 25 or 200.

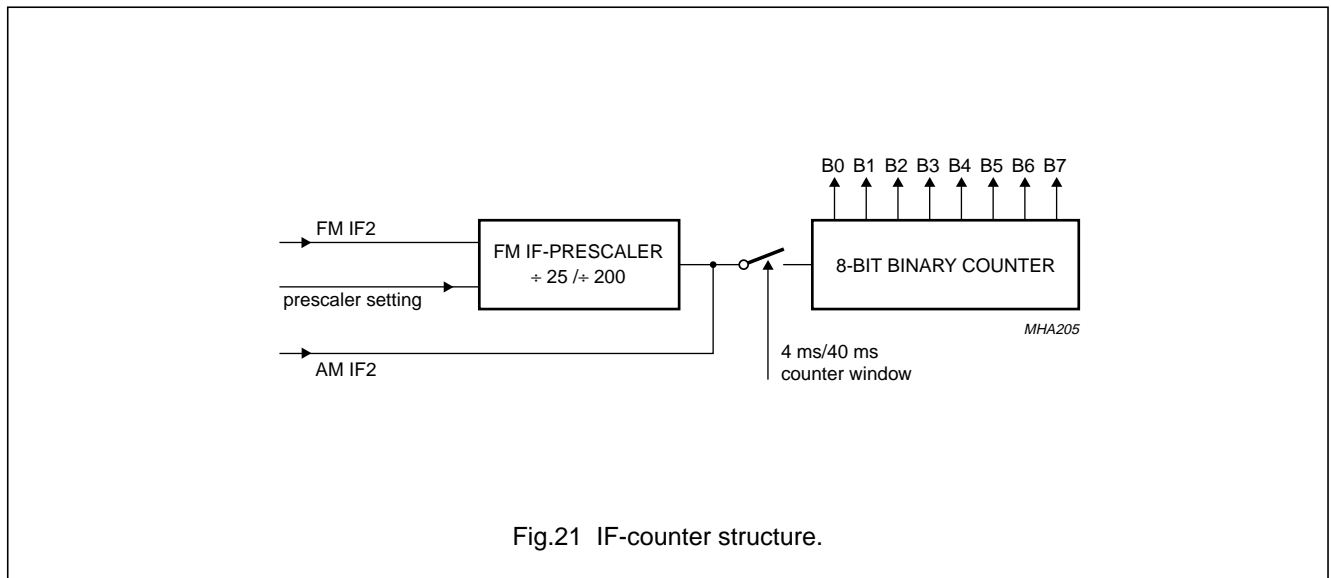

## In Car Entertainment (ICE) car radio

## TEA6823T; TEA6825T

*IF-counter read out***IF-counter read out as a function of FM or AM position, counter window and prescaler setting**

| FM/AM             | PRESCALER RATIO | WINDOW (ms) | f <sub>IF</sub> (kHz) | READ OUT | RESOLUTION (Hz/count) | RANGE (kHz) |          |
|-------------------|-----------------|-------------|-----------------------|----------|-----------------------|-------------|----------|
|                   |                 |             |                       |          |                       | MIN.        | MAX.     |
| FM                | 200             | 4           | 10700                 | D6H      | 50000                 | 4300        | 17050    |
| FM                | 200             | 40          | 10700                 | 5CH      | 5000                  | 10065       | 11335    |
| FM                | 25              | 4           | 10700                 | B0H      | 6250                  | 9906.25     | 11493.75 |
| FM <sup>(1)</sup> | 25              | 40          | 10700                 | E0H      | 625                   | 10620.63    | 10779.38 |
| AM                | 1               | 4           | 450                   | 08H      | 250                   | 418.25      | 481.75   |
| AM <sup>(1)</sup> | 1               | 40          | 450                   | 50H      | 25                    | 446.83      | 453.18   |

**Note**

1. In position FM with a prescaler ratio of 25, counter window of 40 ms and in position AM with 40 ms counter window ambiguous counting results within the IF filter bandwidth are obtained. The counting range is 127 counts above and 127 counts below the nominal IF of 10.7 MHz for FM and 450 kHz for AM.

The IF-count windows are valid for a crystal oscillator frequency of 61.5 MHz.

The FM/AM switching is carried out by bit 0 of byte 2 of the received data of the IC.

The IF-counter operates continuously.

The IF-counter and window-counter will be reset when the I<sup>2</sup>C-bus logic detects the address of the IC. This disables changes in the latches for the IF-count, while reading this value. If the transmission to the front-end IC is disabled after the synthesizer loop of the TEA6810T/TEA6811T front-end IC has locked for a new frequency, the IF-count will be available after the set measuring time.

The IF-counter starts at 0. The IF-counter output are the **8 least significant bits** of the counting result.

In Car Entertainment (ICE) car radio

TEA6823T; TEA6825T

INTERNAL CIRCUITRY

Table 10 Equivalent pin circuits and pin voltages

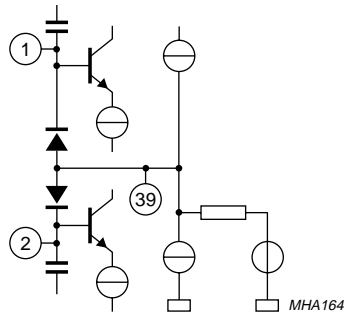
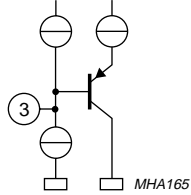
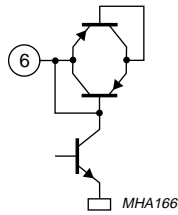
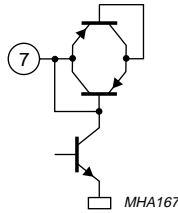
| PIN | SYMBOL            | DC VOLTAGE (V) |            | EQUIVALENT CIRCUIT  |
|-----|-------------------|----------------|------------|---|
|     |                   | AM             | FM         |   |
| 1   | QDET1             | open-circuit   | 4.0        |     |
| 2   | QDET2             | open-circuit   | 4.0        |   |
| 3   | TSWITCH           | open-circuit   | 0.4 to 6.0 |   |
| 4   | AGND              | –              | –          |   |
| 5   | V <sub>DDA1</sub> | 5.0            | 5.0        |   |
| 6   | HFBUS1            | 5.0            | 5.0        |  |
| 7   | HFBUS2            | 5.0            | 5.0        |  |

In Car Entertainment (ICE) car radio

TEA6823T; TEA6825T

| PIN | SYMBOL       | DC VOLTAGE (V) |     | EQUIVALENT CIRCUIT |
|-----|--------------|----------------|-----|--------------------|
|     |              | AM             | FM  |                    |
| 8   | XTAL1        | 4.1            | 4.1 |                    |
| 9   | XTAL2        | 4.1            | 4.1 |                    |
| 10  | $f_{ref(p)}$ | 4.9            | 4.9 |                    |
| 11  | $f_{ref(n)}$ | 4.9            | 4.9 |                    |
| 12  | $I_{ref}$    | 4.3            | 4.3 |                    |
| 13  | FMIF1IN1     | 2.3            | 2.3 |                    |
| 14  | FMIF1IN2     | 2.3            | 2.3 |                    |



In Car Entertainment (ICE) car radio

TEA6823T; TEA6825T

| PIN | SYMBOL           | DC VOLTAGE (V) |            | EQUIVALENT CIRCUIT |
|-----|------------------|----------------|------------|--------------------|
|     |                  | AM             | FM         |                    |
| 15  | TSDR             | 0.7 to 5.5     | 0.7 to 5.5 | <p>MHA172</p>      |
| 16  | TSDS             | 0.7 to 5.5     | 0.7 to 5.5 | <p>MHA173</p>      |
| 17  | V <sub>SDS</sub> | 3.0 to 5.5     | 3.0 to 5.5 | <p>MHA174</p>      |
| 18  | V <sub>SDR</sub> | 3.0 to 5.5     | 3.0 to 5.5 | <p>MHA175</p>      |
| 19  | FMIF2OUT1        | 8.5            | 8.5        | <p>MHA171</p>      |
| 20  | FMIF2OUT2        | 8.5            | 8.5        |                    |

In Car Entertainment (ICE) car radio

TEA6823T; TEA6825T

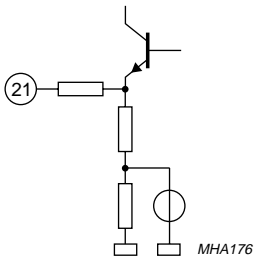
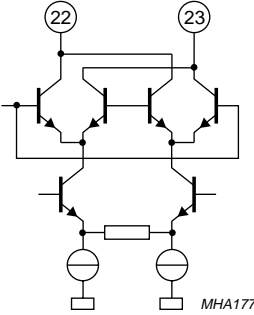
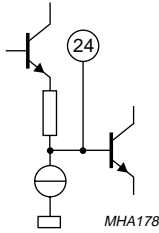
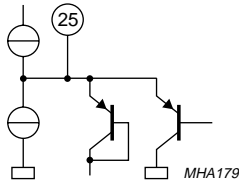
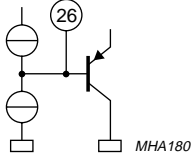
| PIN | SYMBOL           | DC VOLTAGE (V) |            | EQUIVALENT CIRCUIT  |
|-----|------------------|----------------|------------|---|
|     |                  | AM             | FM         |   |
| 21  | V <sub>ref</sub> | 5.1            | 5.1        |  <p>MHA176</p>    |
| 22  | AMIF2OUT1        | 8.5            | 8.5        |  <p>MHA177</p>   |
| 23  | AMIF2OUT2        | 8.5            | 8.5        |   |
| 24  | FMAMDEC          | 3.0            | 2.5        |  <p>MHA178</p> |
| 25  | PHASEDET         | 2.8 to 7.2     | 2.8 to 7.2 |  <p>MHA179</p>  |
| 26  | PILDET           | 0.4            | 0.4 to 7.0 |  <p>MHA180</p> |

In Car Entertainment (ICE) car radio

TEA6823T; TEA6825T

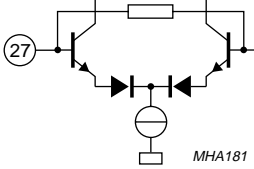
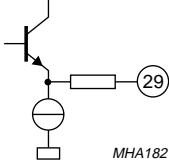
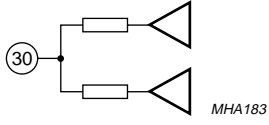
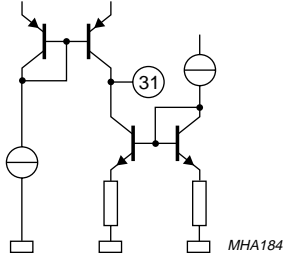
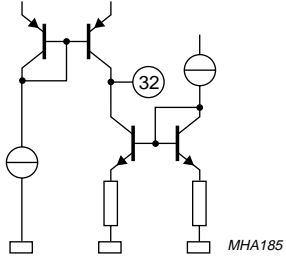
| PIN | SYMBOL            | DC VOLTAGE (V) |     | EQUIVALENT CIRCUIT   |
|-----|-------------------|----------------|-----|--|
|     |                   | AM             | FM  |  |
| 27  | FMAM10.7          | 3.0            | 2.5 |    |
| 28  | V <sub>DDA2</sub> | 8.5            | 8.5 |  |
| 29  | FMIFAMPOUT        | 6.0            | 6.0 |   |
| 30  | AFGND             | 3.6            | 3.6 |   |
| 31  | DEEMPHR           | 2.3            | 2.3 |  |
| 32  | DEEMPHL           | 2.3            | 2.3 |  |

In Car Entertainment (ICE) car radio

TEA6823T; TEA6825T

| PIN | SYMBOL   | DC VOLTAGE (V) |     | EQUIVALENT CIRCUIT |
|-----|----------|----------------|-----|--------------------|
|     |          | AM             | FM  |                    |
| 33  | AMIF2IN1 | 2.7            | 0.7 |                    |
| 34  | AMIF2IN2 | 2.7            | 0.7 |                    |
| 35  | FMIN2    | 0.7            | 2.7 |                    |
| 36  | DCFEED   | 2.7            | 2.7 |                    |
| 37  | FMIN1    | 0.7            | 2.7 |                    |
| 38  | LEVELADJ | 2.6            | 2.6 |                    |

In Car Entertainment (ICE) car radio

TEA6823T; TEA6825T

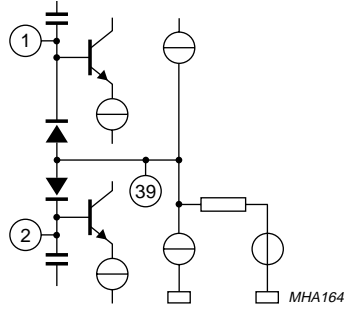
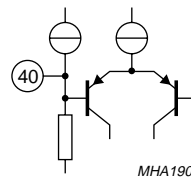
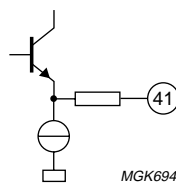
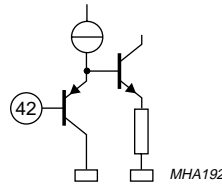
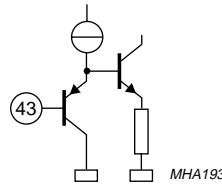
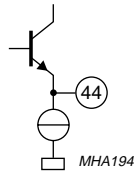
| PIN | SYMBOL           | DC VOLTAGE (V) |            | EQUIVALENT CIRCUIT  |
|-----|------------------|----------------|------------|---|
|     |                  | AM             | FM         |   |
| 39  | C <sub>AFC</sub> | 1.0 to 2.2     | 1.0 to 7.0 |     |
| 40  | MPBUF            | 0.7 to 6.0     | 0.7 to 6.0 |   |
| 41  | OUTLEFT          | 3.6            | 3.6        |  |
| 42  | FMSTOP           | 0 to 5.2       | 0 to 5.2   |   |
| 43  | RDS/AMSTOP       | 0 to 5.2       | 3.0        |   |
| 44  | OUTRIGHT         | 3.6            | 3.6        |  |

In Car Entertainment (ICE) car radio

TEA6823T; TEA6825T

| PIN | SYMBOL                | DC VOLTAGE (V) |            | EQUIVALENT CIRCUIT |
|-----|-----------------------|----------------|------------|--------------------|
|     |                       | AM             | FM         |                    |
| 45  | MPXIN                 | 2.8            | 2.8        |                    |
| 46  | THRES                 | 4.3/5.7        | 4.3/5.7    |                    |
| 47  | MPXOUT                | 0              | 3.0        |                    |
| 48  | AMAFOUT               | 3.7            | 4.8        |                    |
| 49  | V <sub>mute/AML</sub> | 1.0 to 5.5     | 1.0 to 5.5 |                    |
| 50  | LEVELUNWEIG           | 1.0 to 7.0     | 1.0 to 7.0 |                    |

In Car Entertainment (ICE) car radio

TEA6823T; TEA6825T

| PIN | SYMBOL               | DC VOLTAGE (V) |     | EQUIVALENT CIRCUIT |
|-----|----------------------|----------------|-----|--------------------|
|     |                      | AM             | FM  |                    |
| 51  | IAC <sub>CONTR</sub> | 0              | 6.0 |                    |
| 52  | V <sub>DDD</sub>     | 5.0            | 5.0 |                    |
| 53  | SDA                  | 5.0            | 5.0 |                    |
| 54  | SCL                  | 5.0            | 5.0 |                    |
| 55  | DGND                 | 0              | 0   |                    |
| 56  | V <sub>DDA3</sub>    | 8.5            | 8.5 |                    |

In Car Entertainment (ICE) car radio

TEA6823T; TEA6825T

APPLICATION INFORMATION

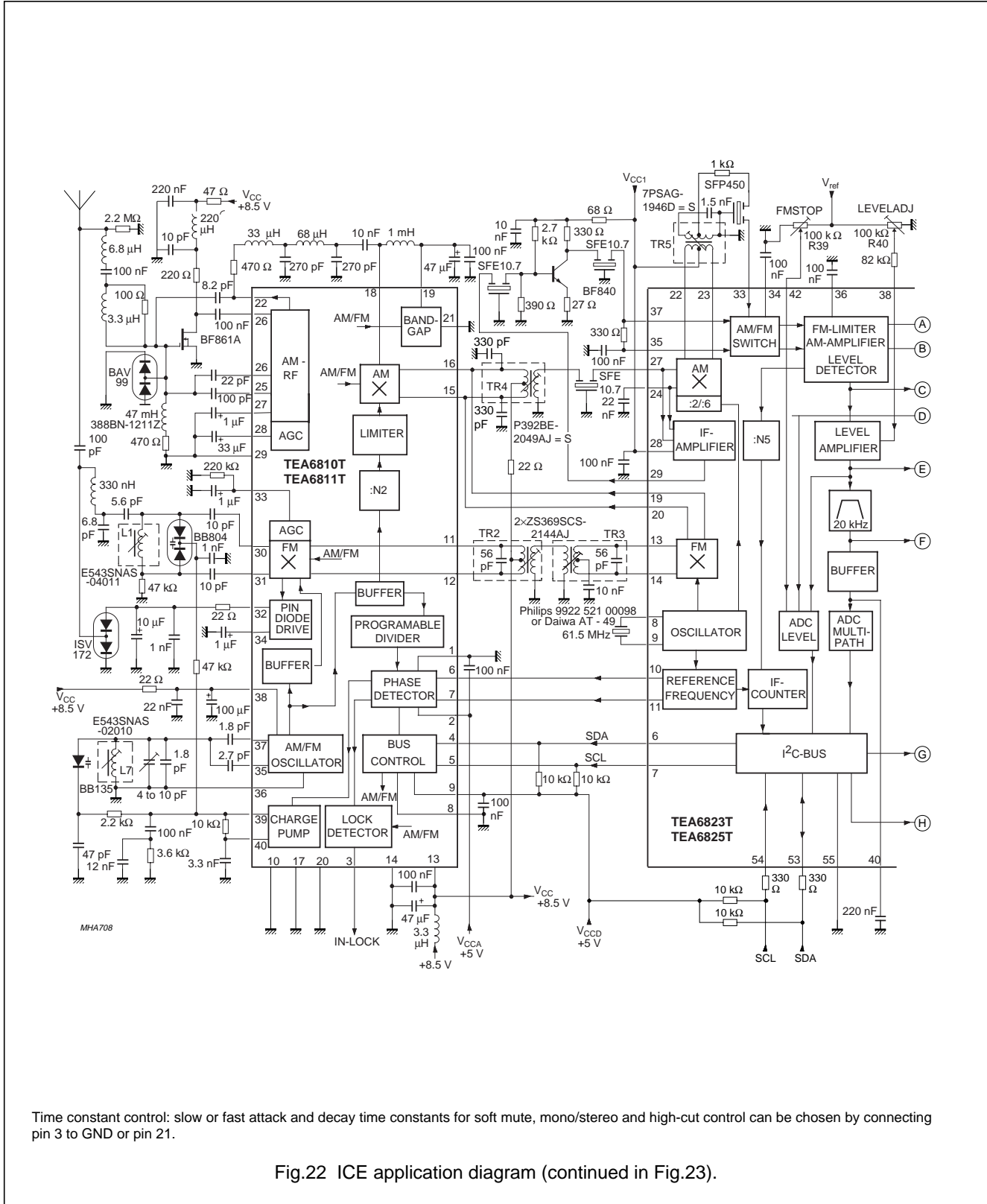



# In Car Entertainment (ICE) car radio

# TEA6823T; TEA6825T

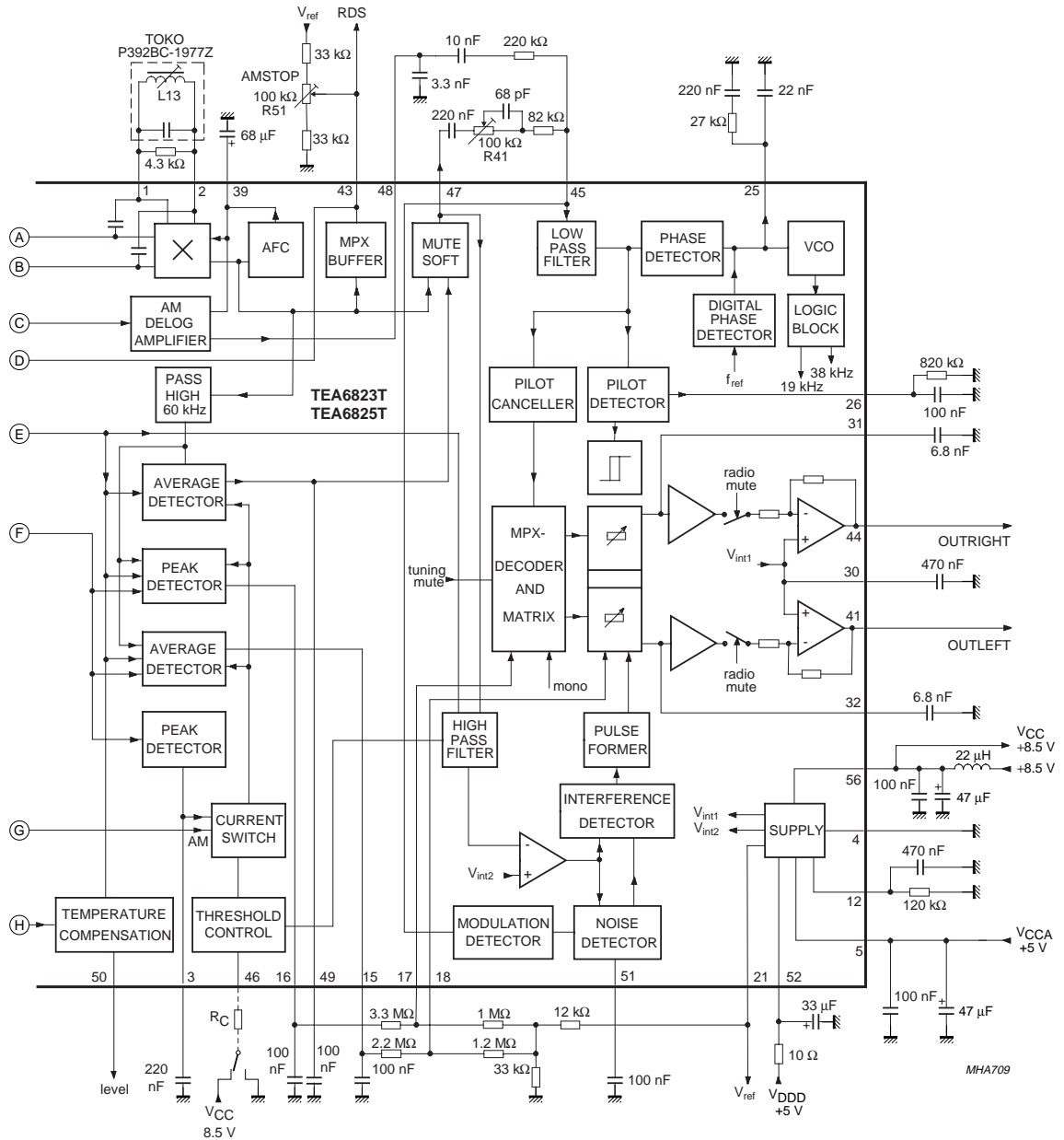

Fig.23 ICE application diagram (continued from Fig.22).

# In Car Entertainment (ICE) car radio

## TEA6823T; TEA6825T

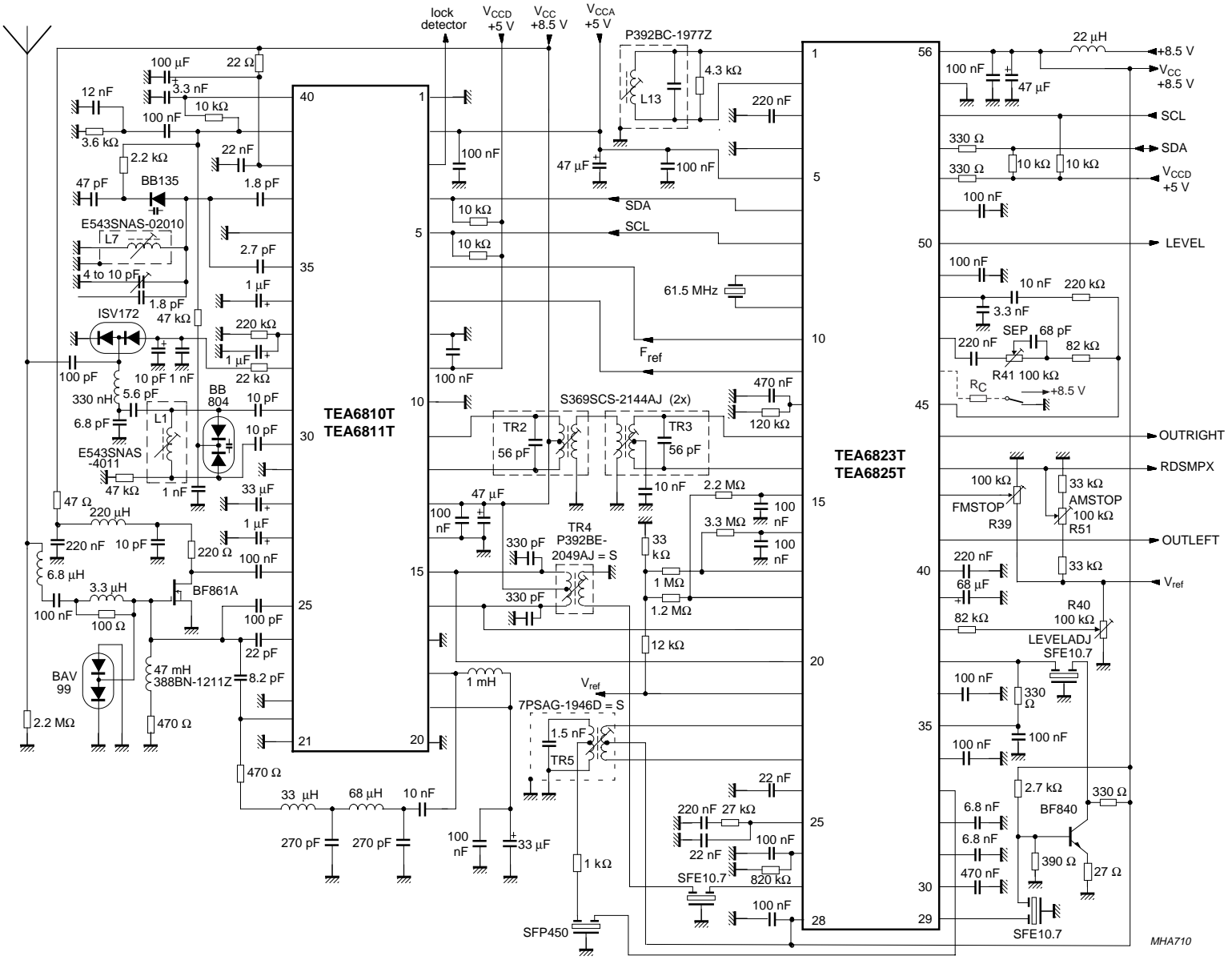

Fig.24 AM/FM car radio receiver with TEA6810T and TEA6825T or TEA6811T and TEA6823T.

MHA710

In Car Entertainment (ICE) car radio

TEA6823T; TEA6825T

PACKAGE OUTLINES

VSO56: plastic very small outline package; 56 leads

SOT190-1

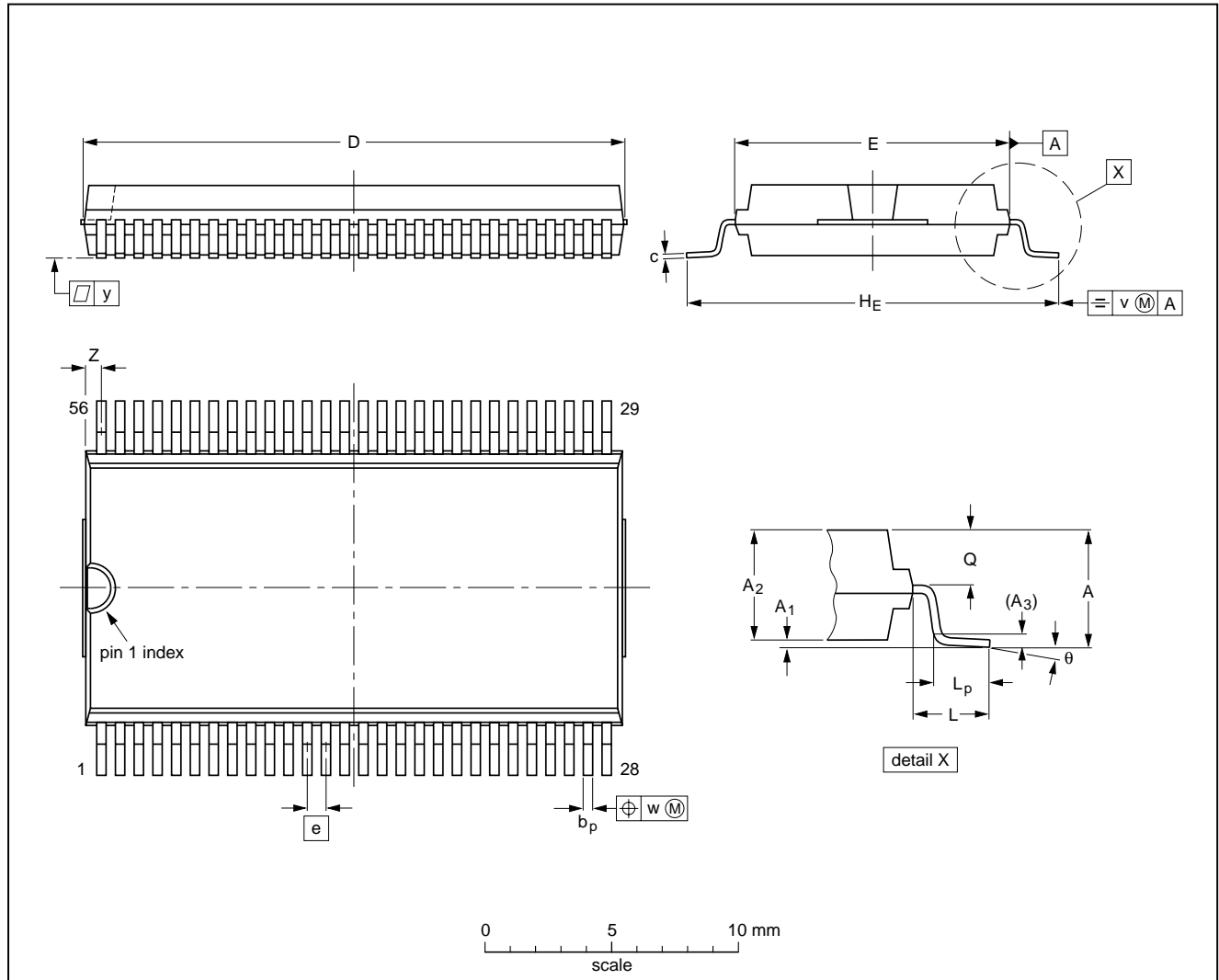

DIMENSIONS (inch dimensions are derived from the original mm dimensions)

| UNIT   | A max. | A <sub>1</sub> | A <sub>2</sub> | A <sub>3</sub> | b <sub>p</sub> | c                | D <sup>(1)</sup> | E <sup>(2)</sup> | e      | H <sub>E</sub> | L     | L <sub>p</sub> | Q              | v     | w     | y     | z <sup>(1)</sup> | θ        |
|--------|--------|----------------|----------------|----------------|----------------|------------------|------------------|------------------|--------|----------------|-------|----------------|----------------|-------|-------|-------|------------------|----------|
| mm     | 3.3    | 0.3<br>0.1     | 3.0<br>2.8     | 0.25           | 0.42<br>0.30   | 0.22<br>0.14     | 21.65<br>21.35   | 11.1<br>11.0     | 0.75   | 15.8<br>15.2   | 2.25  | 1.6<br>1.4     | 1.45<br>1.30   | 0.2   | 0.1   | 0.1   | 0.90<br>0.55     | 7°<br>0° |
| inches | 0.13   | 0.012<br>0.004 | 0.12<br>0.11   | 0.01           | 0.017<br>0.012 | 0.0087<br>0.0055 | 0.85<br>0.84     | 0.44<br>0.43     | 0.0295 | 0.62<br>0.60   | 0.089 | 0.063<br>0.055 | 0.057<br>0.051 | 0.008 | 0.004 | 0.004 | 0.035<br>0.022   |          |

Note

1. Plastic or metal protrusions of 0.3 mm maximum per side are not included.
2. Plastic interlead protrusions of 0.25 mm maximum per side are not included.

| OUTLINE VERSION | REFERENCES |       |      |  | EUROPEAN PROJECTION | ISSUE DATE           |
|-----------------|------------|-------|------|--|---------------------|----------------------|
|                 | IEC        | JEDEC | EIAJ |  |                     |                      |
| SOT190-1        |            |       |      |  |                     | 96-04-02<br>97-08-11 |

In Car Entertainment (ICE) car radio

TEA6823T; TEA6825T

VSO56: plastic very small outline package; 56 leads; face down

SOT190-2

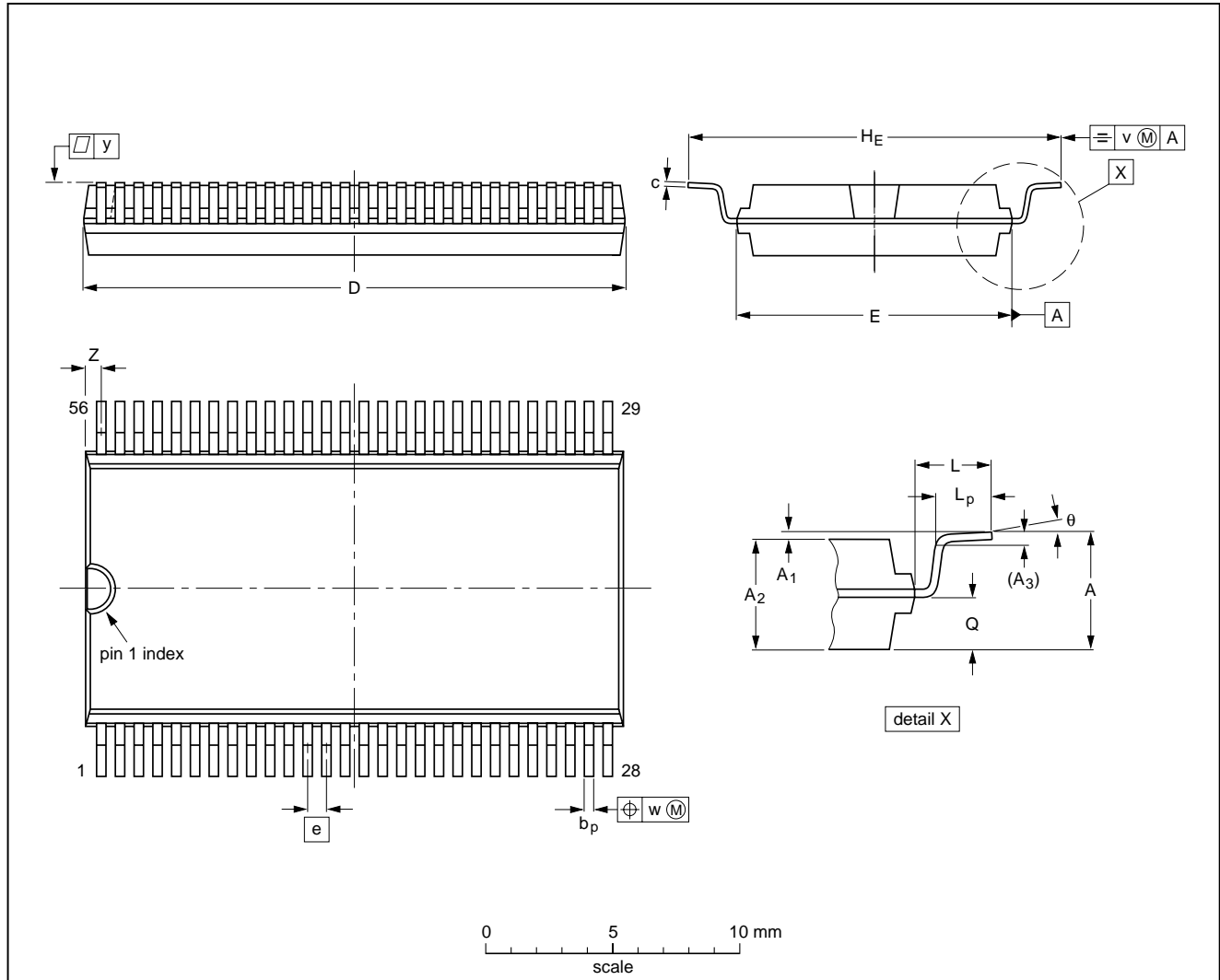

DIMENSIONS (inch dimensions are derived from the original mm dimensions)

| UNIT   | A max. | A <sub>1</sub> | A <sub>2</sub> | A <sub>3</sub> | b <sub>p</sub> | c                | D <sup>(1)</sup> | E <sup>(2)</sup> | e      | H <sub>E</sub> | L     | L <sub>p</sub> | Q              | v     | w     | y     | z <sup>(1)</sup> | θ        |
|--------|--------|----------------|----------------|----------------|----------------|------------------|------------------|------------------|--------|----------------|-------|----------------|----------------|-------|-------|-------|------------------|----------|
| mm     | 3.3    | 0.3<br>0.1     | 3.0<br>2.8     | 0.25           | 0.42<br>0.30   | 0.22<br>0.14     | 21.65<br>21.35   | 11.1<br>11.0     | 0.75   | 15.8<br>15.2   | 2.25  | 1.6<br>1.4     | 1.45<br>1.30   | 0.2   | 0.1   | 0.1   | 0.90<br>0.55     | 7°<br>0° |
| inches | 0.13   | 0.012<br>0.004 | 0.12<br>0.11   | 0.01           | 0.017<br>0.012 | 0.0087<br>0.0055 | 0.85<br>0.84     | 0.44<br>0.43     | 0.0295 | 0.62<br>0.60   | 0.089 | 0.063<br>0.055 | 0.057<br>0.051 | 0.008 | 0.004 | 0.004 | 0.035<br>0.022   |          |

Note

1. Plastic or metal protrusions of 0.3 mm maximum per side are not included.
2. Plastic interlead protrusions of 0.25 mm maximum per side are not included.

| OUTLINE VERSION | REFERENCES |       |      |  | EUROPEAN PROJECTION | ISSUE DATE           |
|-----------------|------------|-------|------|--|---------------------|----------------------|
|                 | IEC        | JEDEC | EIAJ |  |                     |                      |
| SOT190-2        |            |       |      |  |                     | 96-04-02<br>97-08-11 |

---

## In Car Entertainment (ICE) car radio

## TEA6823T; TEA6825T

---

### SOLDERING

#### Introduction

There is no soldering method that is ideal for all IC packages. Wave soldering is often preferred when through-hole and surface mounted components are mixed on one printed-circuit board. However, wave soldering is not always suitable for surface mounted ICs, or for printed-circuits with high population densities. In these situations reflow soldering is often used.

This text gives a very brief insight to a complex technology. A more in-depth account of soldering ICs can be found in our *"Data Handbook IC26; Integrated Circuit Packages"* (order code 9398 652 90011).

#### Reflow soldering

Reflow soldering techniques are suitable for all VSO packages.

Reflow soldering requires solder paste (a suspension of fine solder particles, flux and binding agent) to be applied to the printed-circuit board by screen printing, stencilling or pressure-syringe dispensing before package placement.

Several techniques exist for reflowing; for example, thermal conduction by heated belt. Dwell times vary between 50 and 300 seconds depending on heating method. Typical reflow temperatures range from 215 to 250 °C.

Preheating is necessary to dry the paste and evaporate the binding agent. Preheating duration: 45 minutes at 45 °C.

#### Wave soldering

Wave soldering techniques can be used for all VSO packages if the following conditions are observed:

- A double-wave (a turbulent wave with high upward pressure followed by a smooth laminar wave) soldering technique should be used.
- The longitudinal axis of the package footprint must be parallel to the solder flow.
- The package footprint must incorporate solder thieves at the downstream end.

During placement and before soldering, the package must be fixed with a droplet of adhesive. The adhesive can be applied by screen printing, pin transfer or syringe dispensing. The package can be soldered after the adhesive is cured.

Maximum permissible solder temperature is 260 °C, and maximum duration of package immersion in solder is 10 seconds, if cooled to less than 150 °C within 6 seconds. Typical dwell time is 4 seconds at 250 °C.

A mildly-activated flux will eliminate the need for removal of corrosive residues in most applications.

#### Repairing soldered joints

Fix the component by first soldering two diagonally-opposite end leads. Use only a low voltage soldering iron (less than 24 V) applied to the flat part of the lead. Contact time must be limited to 10 seconds at up to 300 °C. When using a dedicated tool, all other leads can be soldered in one operation within 2 to 5 seconds between 270 and 320 °C.

## In Car Entertainment (ICE) car radio

TEA6823T; TEA6825T

**DEFINITIONS**

|   |   |
|---|---|
| <b>Data sheet status</b>  |   |
| Objective specification   | This data sheet contains target or goal specifications for product development.       |
| Preliminary specification   | This data sheet contains preliminary data; supplementary data may be published later. |
| Product specification   | This data sheet contains final product specifications.                                |
| <b>Limiting values</b>  |   |
| Limiting values given are in accordance with the Absolute Maximum Rating System (IEC 134). Stress above one or more of the limiting values may cause permanent damage to the device. These are stress ratings only and operation of the device at these or at any other conditions above those given in the Characteristics sections of the specification is not implied. Exposure to limiting values for extended periods may affect device reliability. |   |
| <b>Application information</b>  |   |
| Where application information is given, it is advisory and does not form part of the specification.   |   |

**LIFE SUPPORT APPLICATIONS**

These products are not designed for use in life support appliances, devices, or systems where malfunction of these products can reasonably be expected to result in personal injury. Philips customers using or selling these products for use in such applications do so at their own risk and agree to fully indemnify Philips for any damages resulting from such improper use or sale

**PURCHASE OF PHILIPS I<sup>2</sup>C COMPONENTS**

Purchase of Philips I<sup>2</sup>C components conveys a license under the Philips' I<sup>2</sup>C patent to use the components in the I<sup>2</sup>C system provided the system conforms to the I<sup>2</sup>C specification defined by Philips. This specification can be ordered using the code 9398 393 40011.

In Car Entertainment (ICE) car radio

TEA6823T; TEA6825T

---

**NOTES**

# Philips Semiconductors – a worldwide company

**Argentina:** see South America

**Australia:** 34 Waterloo Road, NORTH RYDE, NSW 2113,  
Tel. +61 2 9805 4455, Fax. +61 2 9805 4466

**Austria:** Computerstr. 6, A-1101 WIEN, P.O. Box 213, Tel. +43 160 1010,  
Fax. +43 160 101 1210

**Belarus:** Hotel Minsk Business Center, Bld. 3, r. 1211, Volodarski Str. 6,  
220050 MINSK, Tel. +375 172 200 733, Fax. +375 172 200 773

**Belgium:** see The Netherlands

**Brazil:** see South America

**Bulgaria:** Philips Bulgaria Ltd., Energoproject, 15th floor,  
51 James Bourchier Blvd., 1407 SOFIA,  
Tel. +359 2 689 211, Fax. +359 2 689 102

**Canada:** PHILIPS SEMICONDUCTORS/COMPONENTS,  
Tel. +1 800 234 7381

**China/Hong Kong:** 501 Hong Kong Industrial Technology Centre,  
72 Tat Chee Avenue, Kowloon Tong, HONG KONG,  
Tel. +852 2319 7888, Fax. +852 2319 7700

**Colombia:** see South America

**Czech Republic:** see Austria

**Denmark:** Prags Boulevard 80, PB 1919, DK-2300 COPENHAGEN S,  
Tel. +45 32 88 2636, Fax. +45 31 57 0044

**Finland:** Sinikalliontie 3, FIN-02630 ESPOO,  
Tel. +358 9 615800, Fax. +358 9 61580920

**France:** 51 Rue Carnot, BP317, 92156 SURESNES Cedex,  
Tel. +33 1 40 99 6161, Fax. +33 1 40 99 6427

**Germany:** Hammerbrookstraße 69, D-20097 HAMBURG,  
Tel. +49 40 23 53 60, Fax. +49 40 23 536 300

**Greece:** No. 15, 25th March Street, GR 17778 TAVROS/ATHENS,  
Tel. +30 1 4894 339/239, Fax. +30 1 4814 240

**Hungary:** see Austria

**India:** Philips INDIA Ltd, Band Box Building, 2nd floor,  
254-D, Dr. Annie Besant Road, Worli, MUMBAI 400 025,  
Tel. +91 22 493 8541, Fax. +91 22 493 0966

**Indonesia:** see Singapore

**Ireland:** Newstead, Clonskeagh, DUBLIN 14,  
Tel. +353 1 7640 000, Fax. +353 1 7640 200

**Israel:** RAPAC Electronics, 7 Kehilat Saloniki St, PO Box 18053,  
TEL AVIV 61180, Tel. +972 3 645 0444, Fax. +972 3 649 1007

**Italy:** PHILIPS SEMICONDUCTORS, Piazza IV Novembre 3,  
20124 MILANO, Tel. +39 2 6752 2531, Fax. +39 2 6752 2557

**Japan:** Philips Bldg 13-37, Kohnan 2-chome, Minato-ku, TOKYO 108,  
Tel. +81 3 3740 5130, Fax. +81 3 3740 5077

**Korea:** Philips House, 260-199 Itaewon-dong, Yongsan-ku, SEOUL,  
Tel. +82 2 709 1412, Fax. +82 2 709 1415

**Malaysia:** No. 76 Jalan Universiti, 46200 PETALING JAYA, SELANGOR,  
Tel. +60 3 750 5214, Fax. +60 3 757 4880

**Mexico:** 5900 Gateway East, Suite 200, EL PASO, TEXAS 79905,  
Tel. +9-5 800 234 7381

**Middle East:** see Italy

**Netherlands:** Postbus 90050, 5600 PB EINDHOVEN, Bldg. VB,  
Tel. +31 40 27 82785, Fax. +31 40 27 88399

**New Zealand:** 2 Wagener Place, C.P.O. Box 1041, AUCKLAND,  
Tel. +64 9 849 4160, Fax. +64 9 849 7811

**Norway:** Box 1, Manglerud 0612, OSLO,  
Tel. +47 22 74 8000, Fax. +47 22 74 8341

**Philippines:** Philips Semiconductors Philippines Inc.,  
106 Valero St. Salcedo Village, P.O. Box 2108 MCC, MAKATI,  
Metro MANILA, Tel. +63 2 816 6380, Fax. +63 2 817 3474

**Poland:** Ul. Lukiska 10, PL 04-123 WARSZAWA,  
Tel. +48 22 612 2831, Fax. +48 22 612 2327

**Portugal:** see Spain

**Romania:** see Italy

**Russia:** Philips Russia, Ul. Usatcheva 35A, 119048 MOSCOW,  
Tel. +7 095 755 6918, Fax. +7 095 755 6919

**Singapore:** Lorong 1, Toa Payoh, SINGAPORE 1231,  
Tel. +65 350 2538, Fax. +65 251 6500

**Slovakia:** see Austria

**Slovenia:** see Italy

**South Africa:** S.A. PHILIPS Pty Ltd., 195-215 Main Road Martindale,  
2092 JOHANNESBURG, P.O. Box 7430 Johannesburg 2000,  
Tel. +27 11 470 5911, Fax. +27 11 470 5494

**South America:** Al. Vicente Pinzon, 173, 6th floor,  
04547-130 SÃO PAULO, SP, Brazil,  
Tel. +55 11 821 2333, Fax. +55 11 821 2382

**Spain:** Balmes 22, 08007 BARCELONA,  
Tel. +34 3 301 6312, Fax. +34 3 301 4107

**Sweden:** Kottbygatan 7, Akalla, S-16485 STOCKHOLM,  
Tel. +46 8 632 2000, Fax. +46 8 632 2745

**Switzerland:** Allmendstrasse 140, CH-8027 ZÜRICH,  
Tel. +41 1 488 2686, Fax. +41 1 488 3263

**Taiwan:** Philips Semiconductors, 6F, No. 96, Chien Kuo N. Rd., Sec. 1,  
TAIPEI, Taiwan Tel. +886 2 2134 2865, Fax. +886 2 2134 2874

**Thailand:** PHILIPS ELECTRONICS (THAILAND) Ltd.,  
209/2 Sanpavuth-Bangna Road Prakanong, BANGKOK 10260,  
Tel. +66 2 745 4090, Fax. +66 2 398 0793

**Turkey:** Talatpasa Cad. No. 5, 80640 GÜLTEPE/ISTANBUL,  
Tel. +90 212 279 2770, Fax. +90 212 282 6707

**Ukraine:** PHILIPS UKRAINE, 4 Patrice Lumumba str., Building B, Floor 7,  
252042 KIEV, Tel. +380 44 264 2776, Fax. +380 44 268 0461

**United Kingdom:** Philips Semiconductors Ltd., 276 Bath Road, Hayes,  
MIDDLESEX UB3 5BX, Tel. +44 181 730 5000, Fax. +44 181 754 8421

**United States:** 811 East Arques Avenue, SUNNYVALE, CA 94088-3409,  
Tel. +1 800 234 7381

**Uruguay:** see South America

**Vietnam:** see Singapore

**Yugoslavia:** PHILIPS, Trg N. Pasica 5/v, 11000 BEOGRAD,  
Tel. +381 11 625 344, Fax. +381 11 635 777

**For all other countries apply to:** Philips Semiconductors,  
International Marketing & Sales Communications, Building BE-p, P.O. Box 218,  
5600 MD EINDHOVEN, The Netherlands, Fax. +31 40 27 24825

**Internet:** <http://www.semiconductors.philips.com>

© Philips Electronics N.V. 1998

SCA57

All rights are reserved. Reproduction in whole or in part is prohibited without the prior written consent of the copyright owner.

The information presented in this document does not form part of any quotation or contract, is believed to be accurate and reliable and may be changed without notice. No liability will be accepted by the publisher for any consequence of its use. Publication thereof does not convey nor imply any license under patent- or other industrial or intellectual property rights.

Printed in The Netherlands

545102/1200/01/pp48

Date of release: 1998 Mar 24

Document order number: 9397 750 02316

*Let's make things better.*

**Philips  
Semiconductors**



**PHILIPS**



This datasheet has been download from:

[www.datasheetcatalog.com](http://www.datasheetcatalog.com)

Datasheets for electronics components.